

HALOGEN SOFTWARE



HAL SYSTEM OVERVIEW

★ **New! RAD26 One Room RAD**

page 22

★ **New! Halogen Event Manager**

page 30

HAL Hardware

HAL Introduction	2
HAL 1x and Expanders Comparison	3
HAL 1x Multiprocessor	4
HAL2 Multiprocessor	4
HAL3s Multiprocessor	5
HAL4 Multiprocessor	5
The HAL1x Expansion Bus	6
EXP1x RAD Expander	7
EXP2x Dante Expander	8
Rane Dante Solutions	9
EXP3x Zone Output Expander	12
EXP5x Input Expander	13
EXP7x AEC Expander	14
Ethernet, RAD and DR Cable Lengths	15
RADs	16
AM1 and AM2 Automixers as RADs	21

Halogen Software

Halogen Software	28
Halogen Processing Blocks	31
Event Manager	30

Control HAL

Digital Remotes	32
Halogen Web Controls	35
Logic, Analog Control Inputs and Outputs	36
AMX, Crestron and Stardraw Support Packages	36

HAL Applications

Room Combining with the IR2	37
Multizone Paging with the PAGER1	38
Acoustic Echo Canceling (AEC) with the EXP7x	39
Example HAL1x Boardroom System with AEC	41
Example HAL2 Auditorium with Web Controls	42
Example HAL3s Restaurant Music and Paging System	43
Example HAL4 Music and Paging System	44

Trademarks

• Heuristic Audio Laboratory (HAL)® • HAL and Halogen are trademarks of Rane Corporation • AMX® and the AMX logo are registered trademarks of AMX • Stardraw Control is a trademark of Stardraw.com Ltd. • Crestron® is a registered trademark of Crestron Electronics, Inc. • Decora® is a registered trademark of Leviton • Dante is a trademark of Audinate Pty Ltd, Audinate is a registered trademark of Audinate Pty Ltd. • Windows® is a registered trademark of Microsoft Corporation in the United States and other countries. • Apple, Mac, Macintosh, iPhone, iPad, iTunes, Safari, QuickTime, GarageBand, and OSX are registered trademarks of Apple Inc., registered in the U.S. and other countries.

HAL Introduction

HAL is more than just another DSP drag-and-drop system. It has revolutionized system design and installation.

HAL is an expert in room combining, paging and distributed audio systems. This groundbreaking architecture is dimensions beyond any solution in any industry. HAL easily guides even novice users through what used to be complex tasks in just minutes. No intricate matrix mixing or presets are required for room combining and paging. No virtual wiring is required to distribute pages and background music to multiple, even hundreds of zones.

Seamlessly interface HAL to your application with web controls and/or a broad variety of peripheral devices including smart Digital Remotes, a 7-inch programmable touchscreen, Remote Audio Devices (RADs), portable or rack automixers, audio I/O, Dante, and logic expansion devices, wall sensors, ambient sensing mics, and an advanced Paging Station. Control HAL functions from a web browser in any smartphone, computer or tablet – including iPads, iPhones, Androids, Samsung, etc. The Event Manager can automate HAL's DSP using date and time.

In addition, the HAL Multiprocessor and Halogen™ software check the status, location, CAT 5 wiring integrity, and that audio is flowing in all peripheral devices, so you know your system is properly connected and ready to go. Does your DSP troubleshoot the cable install for you and offer a “Get on the Plane” indicator that shows you that the installers have truly finished their job? It should.

Halogen software includes Ethernet control support for third-party control systems such as AMX®, Crestron® and Stardraw Control™, including well-documented examples. Standard TCP/IP set and get ASCII text messages control levels, selectors, presets and toggle software actions. Since the same Halogen software code runs on both Windows® and within HAL hardware, third-party control developers can test all their code using only the Halogen Windows software. Use only software for complete system design and validation. Buy the hardware only when the install date arrives and completely skip needing it early solely for control system programming verification.

Analog audio has always offered “plug it in, it works!” functionality. With HAL's modern DSP system, finally digital audio offers “plug it in, it works”. Without IP anything, without DHCP servers, without unblocking ports, without firmware mismatches, without hours (or days?) of bad cable termination or swapped cable-pull troubleshooting, and other troubles caused by Ethernet and other supposedly modern digital audio and control transports.

Four HAL models are the base of any system, ranging from a simple 2x2, 6x10, 18x18, and the expandable HAL1x up to 528x528 inputs and outputs.

Download Halogen and design a system now!
rane.com/hal

Applications, installations, and solutions are at
blog.rane.com

HAL1x and Expanders Comparison

HAL1x Multiprocessor

- 16 in x 16 out - 8x8 analog & 8x8 digital (RAD ports).
- Up to 4 RADs (without EXP1x), up to 260 RADs (with 32 EXP1s).
- Up to 12 Digital Remotes (without EXPs), up to 268 (with EXPs).
- Four logic inputs, Two relay outputs (more with DR4 or DR5).

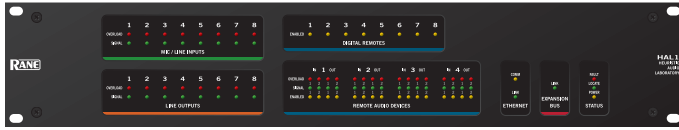

Analog Mic / Line Inputs 8	8 Analog Line Outputs
Digital RAD Port Inputs 8	8 Digital RAD Port Outputs
Digital Expansion into HAL1x 512	512 Digital Expansion from HAL1x
Total in the HAL1x DSP Brain 528	528
Inputs	Outputs

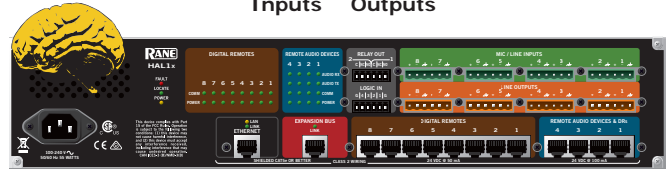

EXP1x Remote Audio Expander for HAL1x

- Adds 16 in x 16 out digital (8 more RAD ports) to HAL1x.
- Up to 8 Digital Remotes or RADs in any combination.
- Chain up to 32 EXP1x units to a HAL1x for 512 in x 512 out.



EXP2x Dante Expander for HAL1x

- Lets HAL1x send and receive 32 channels to a Dante network.
- Supports 44.1, 48, 88.2 or 96 kHz Dante network sample rates.
- Chain up to 16 EXP2x units to a HAL1x for 512 in x 512 out.



EXP3x Zone Output Expander for HAL1x

- Adds 8 analog line outputs and 8 logic outputs to a HAL1x.
- Adds 6 Digital Remote ports & 2 RAD ports to a HAL1x.
- Chain up to 32 EXP3x units to a HAL1x for 256 outputs.



EXP5x Input Expander for HAL1x

- Adds 12 analog mic / line / line-plus* inputs to a HAL1x.
- Adds 4 Digital Remote ports to a HAL1x.
- Chain up to 32 EXP5x units to a HAL1x for 384 analog inputs.



EXP7x AEC Expander for HAL1x

- Adds 8 channels of Acoustic Echo Canceling DSP to a HAL1x.
- Chain up to 32 EXP7x units to a HAL1x for 256 AEC channels.

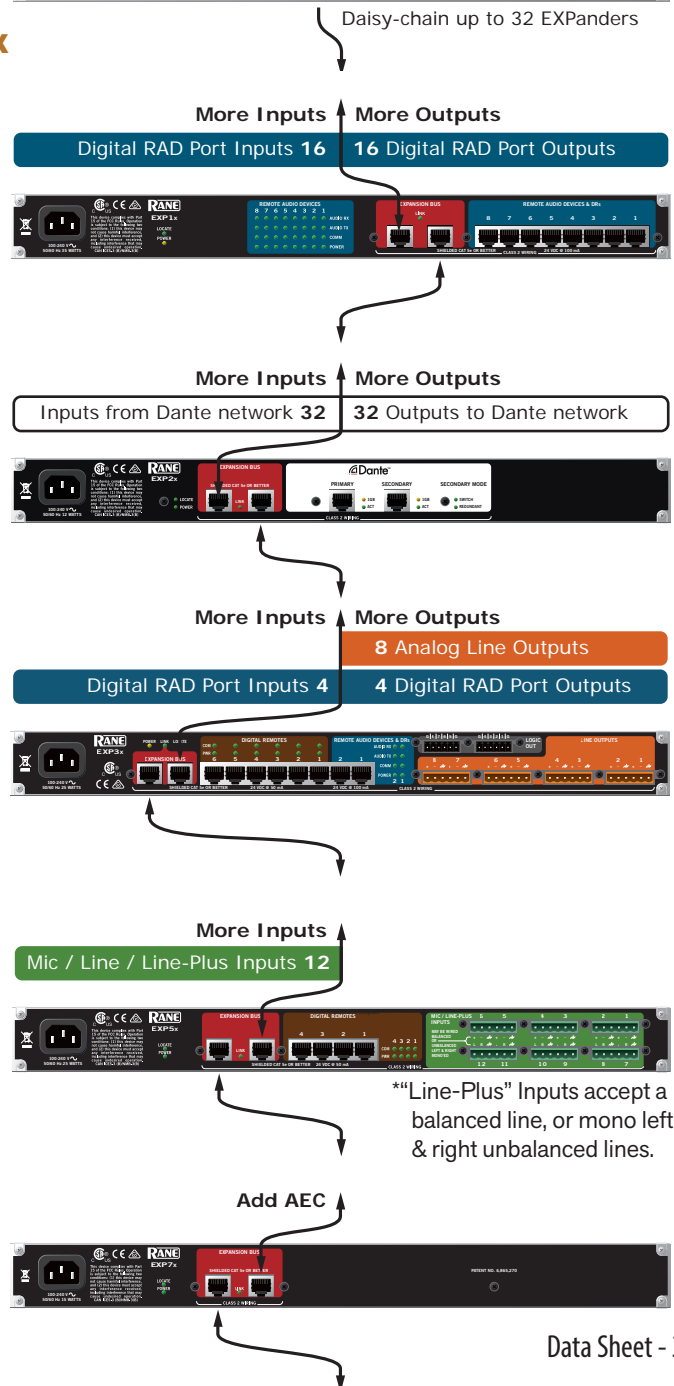

HAL1x Multiprocessor

HAL1x features a 16 x 16 analog/digital I/O, plus an assortment of control ports for Rane’s elegant Digital Remotes. The HAL1x provides access to an array of Expanders (previous page) for

additional inputs, outputs, DSP and AEC for medium to large venues. Up to 32 Expanders can daisy-chain to a single HAL1x. See the full specifications in the HAL1x Data Sheet.



Features

- 16 in x 16 out:
 - 8x8 analog & 8x8 digital (RAD ports).
 - 528 x 528 potential by adding Expanders.
- Up to 12 Digital Remotes.
- Four logic inputs (closure)
- Two relay outputs.



See the HAL1x Expander list on the previous page, and the HAL1x Expansion Bus description on page 6.

HAL2 Multiprocessor

HAL2 features an 18 x 18 combination analog-digital I/O, plus an assortment of control ports for Rane’s Digital Remotes. The HAL2 applies the versatile Halogen software interface to venues that don’t need extensive expansion. It includes the same abilities

to quickly design room combinations, paging systems, distributed music, and automixers with Rane’s “no virtual wiring needed” approach, but in a smaller I/O configuration to meet smaller budgets. See the full specifications in the HAL2 Data Sheet.

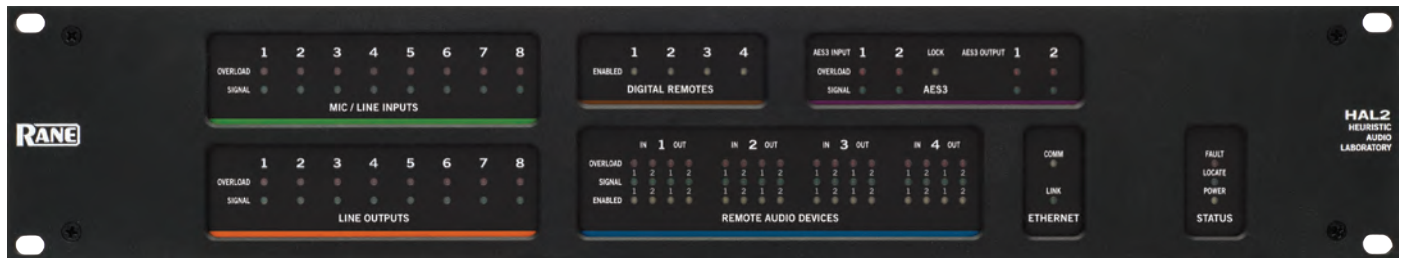

Features

- 18 in x 18 out:
 - 8x8 analog & 8x8 digital (RAD ports).
 - AES3 I/O.
- Up to 8 Digital Remotes.
- Four logic inputs (closure)
- Two relay outputs.
- Four IR Ports for IR2 Wall Sensors.

Analog Mic / Line Inputs 8	8 Analog Line Outputs
Digital RAD Port Inputs 8	8 Digital RAD Port Outputs
(AES3) Input Channels 2	2 (AES3) Output Channels
Total in the HAL2 DSP Brain 18	18

Inputs Outputs

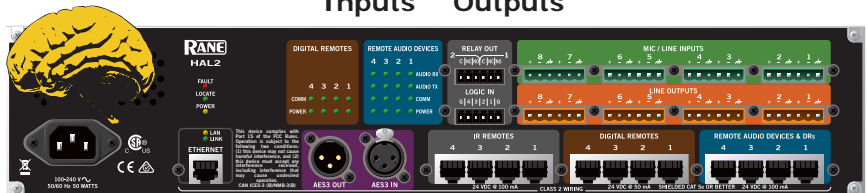

HAL3s Multiprocessor

The improved HAL3s upgrades the HAL3 with an additional RAD port, mic-capable inputs and 10 dB more dynamic range. It fits more installations with an impressive 6 inputs by 10 outputs at a price that fits the budget with the benefits of

open-architecture processing. Add two from Rane's growing army of RADs (Remote Audio Devices) to get two sets of analog inputs and/or outputs up to 150 meters (500 feet) away. Full specifications are in the HAL3s Data Sheet.



Features

- 6 line in x 10 line out:
 - 2x6 analog
 - 4x4 digital (RAD ports).
- Mic / Line / Line-Plus Inputs are configurable:
 - +4 dBu balanced, mic or line level.
 - +48V phantom available in mic mode.
 - -10 dBV unbalanced Left/Right Monoed.
- Up to four Digital Remotes.
- Four logic inputs (closure).

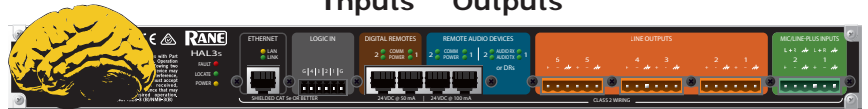
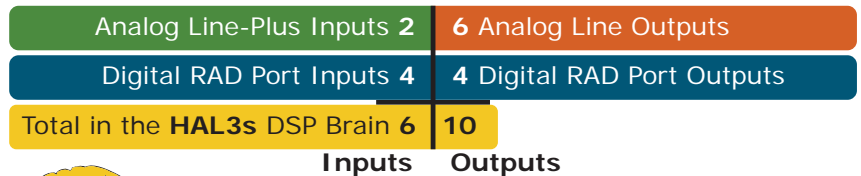

HAL4 Multiprocessor

The HAL4 is a 2-Input, 2-Output drag-and-drop DSP device for Halogen software. It is a stand-alone Halogen replacement for the popular DragNet RPM2 with four-times the processing power, improved digital remote and Web Control support, simplified linking and improved preset recall capability. It solves just about every signal processing problem found in one or two rooms.

to the “+” terminal, the RCA right tip to the “-” terminal, and both RCA shields to the Euroblock ground. Select Line-Plus in Halogen and you get a properly monoed audio channel.

Each of the 2 inputs independently supports a dynamic mic, 48V phantom mic, +4 dBu line-level, or Rane’s Line-Plus input. Line-Plus accepts -10 dBV unbalanced Left/Right Monoed together on the “+” and “-” ports, respectively. For stereo unbalanced sources, Line-Plus allows connecting the stereo RCA left tip

A single DR port provides support for preset recall, level control and select functions using a DR1, DR2, DR3 or DR6. A DR4 or DR5 may be added for other logic I/O.

As with other Halogen host products, the HAL4 connects to a computer via a Gigabit Ethernet Port with Halogen software used for initial system setup. The full suite of processing blocks available with other Halogen host devices is available for the HAL4. No other 2-channel DSP gives this much bang for the buck!

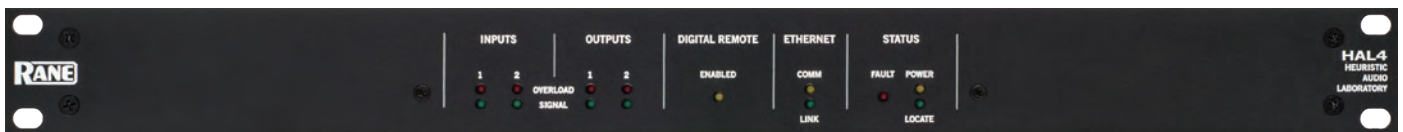

Features

- 2 mic/line/line-plus inputs x 2 line outputs.
- Mic / Line / Line-Plus Inputs are configurable:
 - +4 dBu balanced, mic or line level.
 - +48V phantom available in mic mode.
 - -10 dBV unbalanced Left/Right Monoed.
- One Digital Remote port.



The HAL1x Expansion Bus

The HAL1x Expansion Bus supports up to 32 daisy-chained Expanders in any combination. The Expansion Bus requires shielded CAT 5e (or better) cable with RJ-45 connectors.

The bus supports 512 channels in and 512 out, although designers need not worry about wiring channels along the bus — this is automatically done within Halogen software. The Resources window in Halogen displays the number of channels in use and updates as you draw the audio wiring. Latency hops on the bus are 750 nanoseconds per hop. Thus, daisy-chaining 32 Expanders provides a maximum latency of 22.4 microseconds. See the Latency graphic below to add up the latency of any given path through the HAL1x, EXPs, RADs, the DSPs and converters.

Thirty-two Expanders maximum in any order can be daisy-chained. For example, 16 EXP3x and 16 EXP5x Expanders daisy-chained, provides 128 outputs (8 out times 16), plus 192 mic/line/line-plus inputs (12 in times 16).

Some examples max out the Expansion Bus:

- If you need 256 RADs, daisy-chain 32 EXP1x Expanders. This is 8 RAD ports times 32 Expanders, 8 x 32 = 256 RADs. This still leaves 4 RAD ports available on the HAL1x.

- For 256 output zones, daisy-chain 32 EXP3x Expanders.
 - For 384 mic/line inputs, daisy-chain 32 EXP5x Expanders.
- Each Expansion Bus cable can be 100 meters long (300 feet). This permits spreading Expanders across different locations or equipment rooms. Yet only a single HAL1x is required at the head-end of the daisy-chain. Star topologies are not supported — don't use Ethernet switches, they won't work. And since the EXP3x & EXP5x contain their own DSP, no DSP resources in the HAL1x device are used; thus adding these devices adds DSP resources to the HAL1x System.

Gigabit Ethernet Media Converters *are* supported. Thus, using multimode fiber, one can separate Expanders up to 2 kilometers (1.2 miles). Singlemode fiber distance goes up to 12 km (7.5 miles). The Expansion Bus is Ethernet Layer 1 only — there are no MAC and no IP addresses involved, therefore dedicated unmanaged media converters must be used.

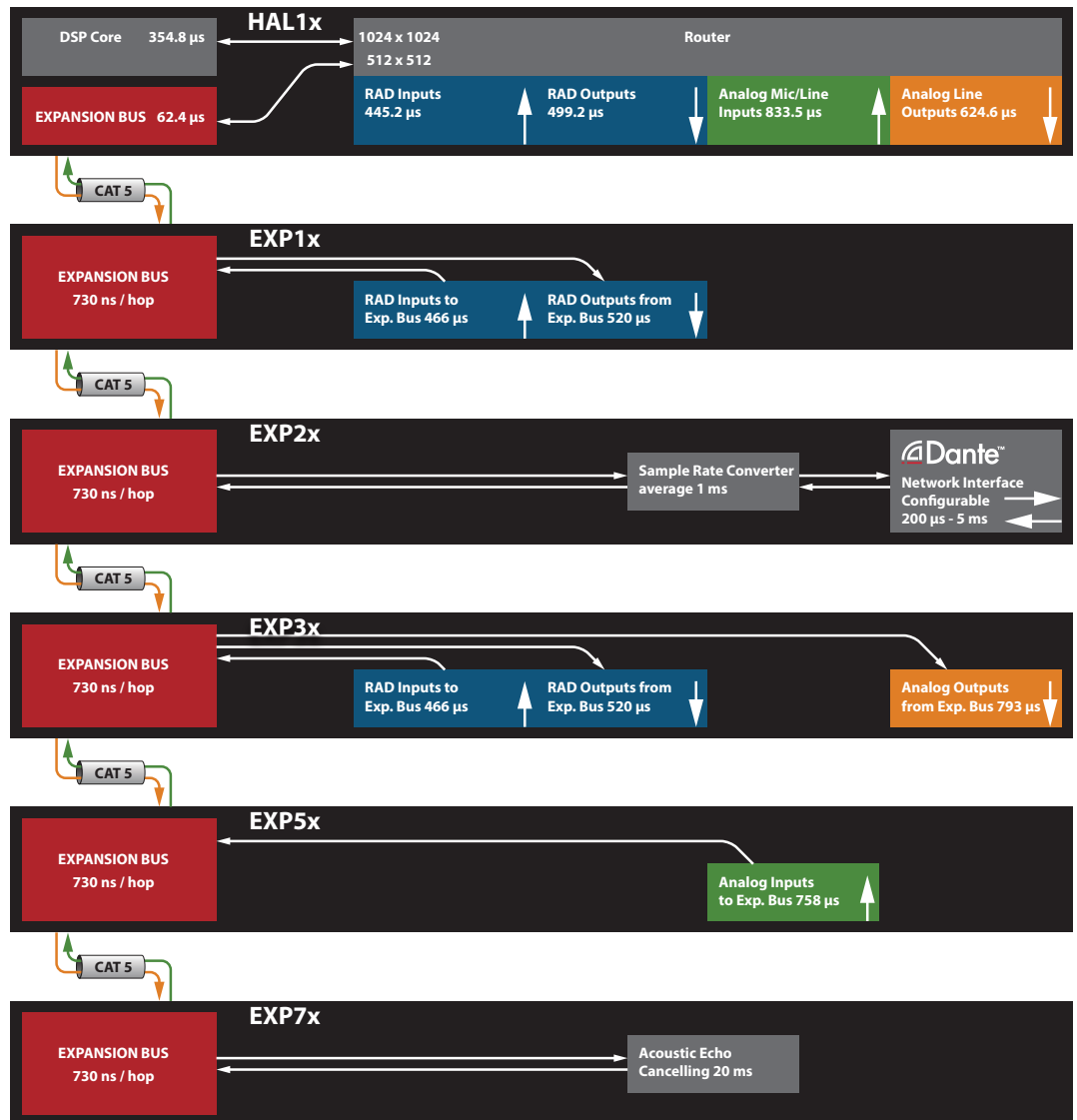



EXP1x RAD Expander

The EXP1x adds eight RAD ports to a HAL1x via the Expansion Bus. The EXP1x requires a HAL1x to operate.

RADs can be the most valuable asset in a HAL system. Shielded CAT 5e (or better) cable and termination transport four digital audio channels – two channels each direction – as well as power, ground and a communications channel, with status indicators at each RAD, HAL1x and EXP1x up to 150 meters (500 feet) away. See all the RADs on page 16.

Note that DR remotes can also be plugged into any RAD port, so the EXP1x makes room for additional DR remotes when needed.

Up to 32 Expanders, in any combination, may be daisy-chained to a single HAL1x, adding 512 inputs and 512 outputs if all 32 are EXP1x units.

The original HAL1 and EXP1 have been replaced with the HAL1x and EXP1x using the improved CAT 5 expansion bus.

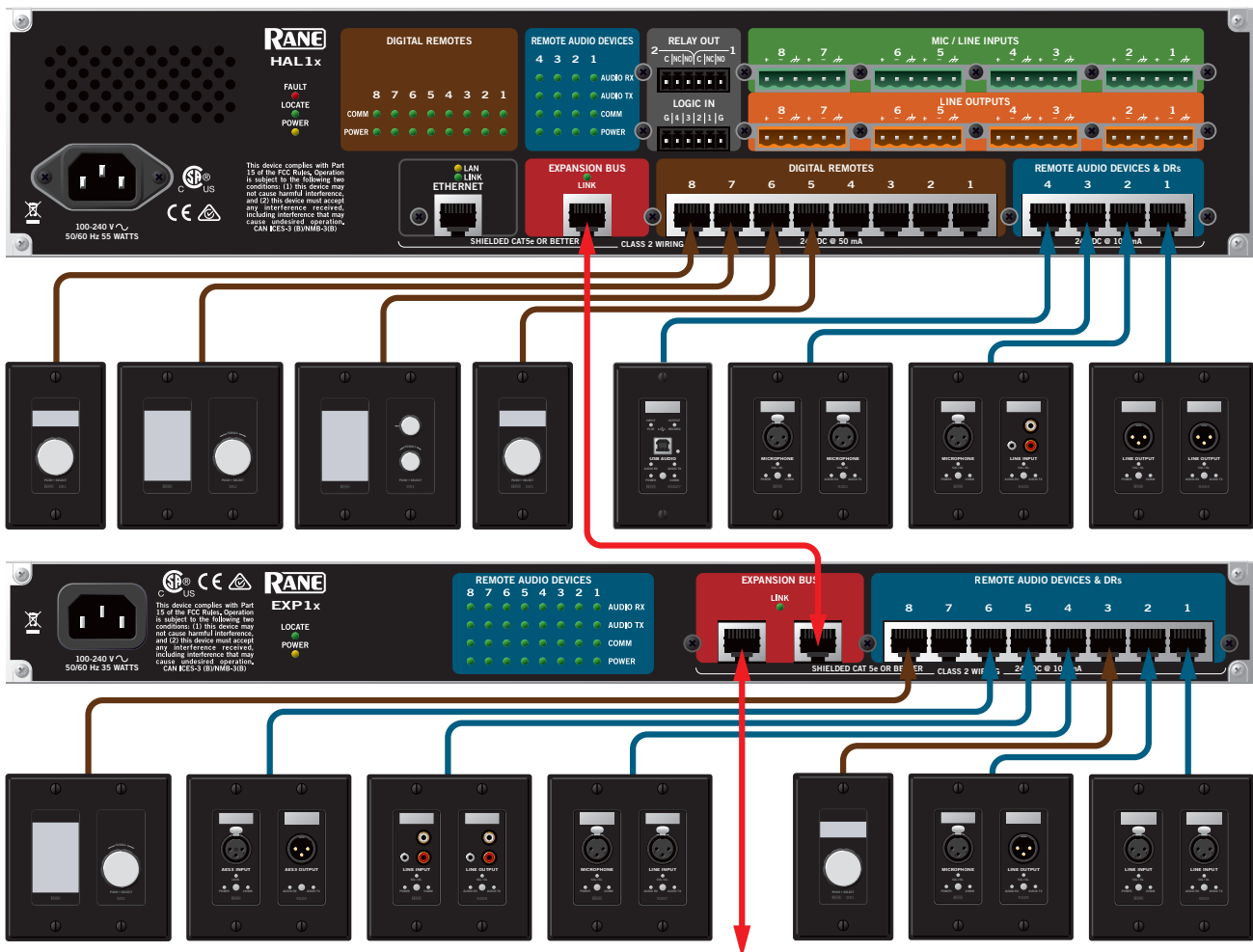

To Additional Expanders



EXP2x Dante Expander

The EXP2x is an input/output expander that enables the HAL1x to transmit 32 and receive 32 audio channels from a Dante™ network. Applications abound in houses of worship, installed sound, performing arts venues, education and corporate environments – anywhere a Dante network is used. The EXP2x also allows connecting a Dante network between multiple independent HAL1x systems.

Built-in sample rate converters convert the 44.1, 48, 88.2 or 96 kHz sample rate on the Dante network to the HAL's 48 kHz clock domain.

Daisy-chain up to 16 EXP2x Expanders to a single HAL1x to max-out at 512 x 512 channels on both a single cable on the Dante network and the HAL1x's Expansion Bus. The HAL1x is capable of 32 Expanders on its bus, so the EXP2x can be combined with other Expanders. For example, use 16 EXP2x Expanders with 512 input and 512 output channels, and then put on another 16 EXP3x Expanders for more outputs.

The EXP2x is equipped with a Secondary Dante port for either Redundant Mode or Switch Mode. Use Dante Controller software for all network audio and EXP2x settings via its Brooklyn II card.

Front panel and Halogen software indicators for Dante connection, network status, flow active, and audio signal present aid troubleshooting. Dante Controller provides all network setup, monitoring, control, diagnostics and troubleshooting beyond compare; while Halogen reads, but does not edit the Dante setup, simplifying which software to use and eliminating conflict.

Dante provides a no-hassle, self-configuring network with ultra-low latency, while providing a true plug-and-play digital audio network using standard Internet Protocols on existing infrastructure — without requiring a dedicated network. The technology is built on global networking standards, making signal distribution more flexible, cost-effective and user-friendly and has been used at some of the largest live events and sophisticated installations worldwide.

Read Rane's Dante Setup Philosophy under the EXP2x tab at rane.com/hal/hal1x.html.

Features

- Supports 44.1, 48, 88.2 or 96 kHz Dante network sample rates.
- Up to 32 transmit channels and up to 32 receive channels (at any supported sample rate - that's right, even at 96 kHz).
- 32 bi-directional channels of high-quality sample rate conversion.
- Switch Mode and Redundant Mode for the Secondary Dante network port.
- Clear signal presence and fault status indication in Halogen Software and on the EXP2x front panel.
- Discoverable and configurable using Dante Controller software.

What Ethernet switch can I use for my Dante network?

Answers to this and many other Dante questions are found at audinate.com/resources/networks-switches. The Cisco 300 Series Ethernet switches are available in many varieties, such as the 10-port, SG300-10. They are very affordable, managed, and some offer PoE versions if needed. If you use an Ethernet switch with “Green” Energy-Efficient Ethernet (IEEE 802.3az) turn off this feature. This green technology can delay packets hundreds of milliseconds which will stop all Dante audio from working.



About Audinate

Audinate revolutionizes AV systems to enable its customers to thrive in a networked world. Audinate's patented Dante media networking technology has been adopted by the leading manufacturers in the professional audio/visual industry. Dante is used extensively for live performance events, commercial installation, broadcast, recording and production, and communications systems. Audinate offices are located in US, United Kingdom and Australia. Visit www.audinate.com for the latest news and information on the company. Dante is Digital Media Networking Perfected.

*Dante is a trademark of Audinate Pty Ltd.
Audinate is a registered trademark of Audinate Pty Ltd.*

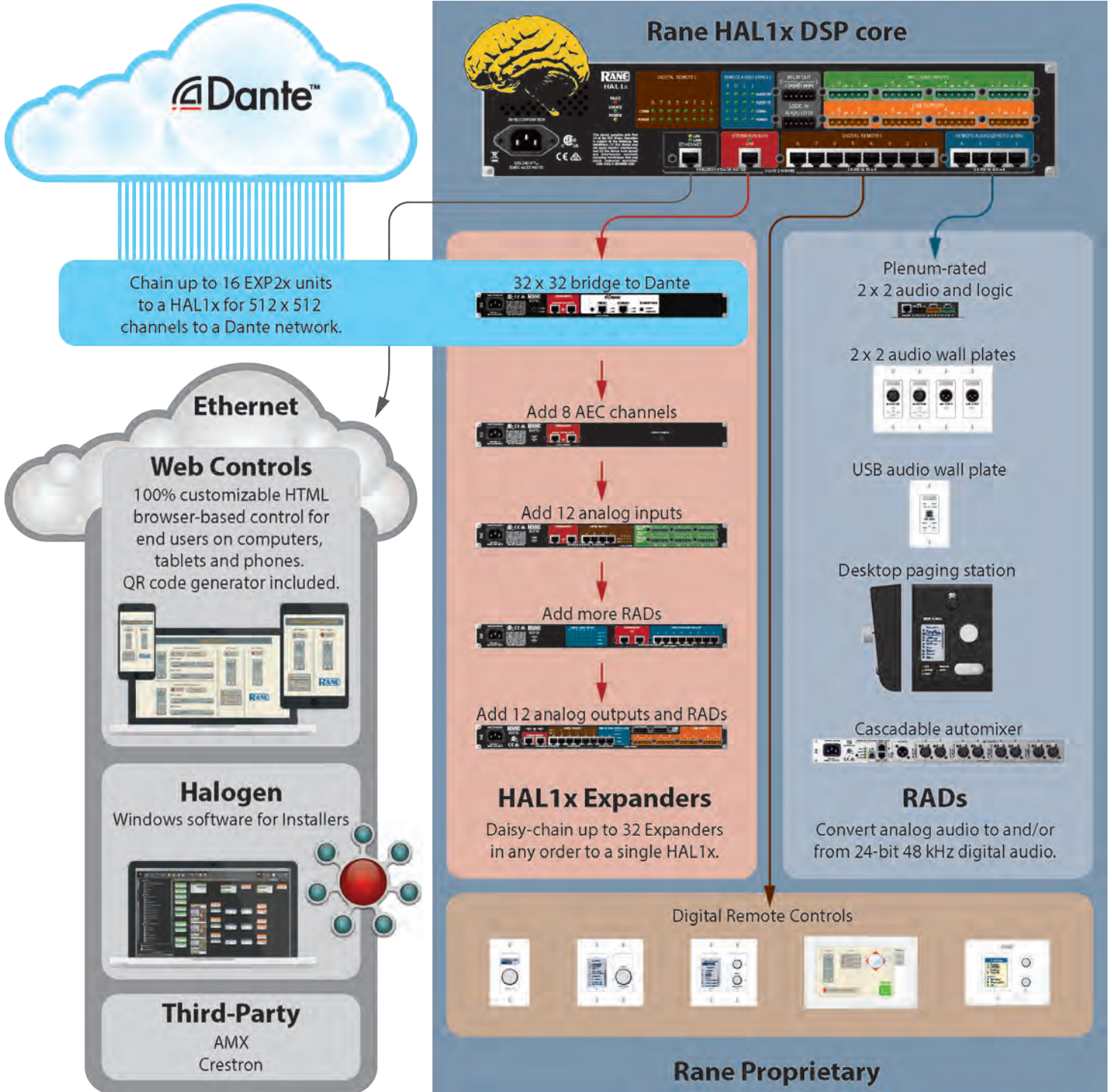

Rane Dante Solutions

- Facility-wide digital audio distribution: including to and from all wall plates.
- Extend your Dante system cost-effectively.
 - One Rane Dante device/license covers all I/O — your entire HAL / DSP System.
 - Pay for Dante only when and where you need it.
- Multipurpose and Divisible Rooms — Combining &/or Overflow.

- Re-assign AEC for Dante & other mics between rooms using HAL presets.
- Incorporate flexible and intuitive end user controls.
 - Create custom tablet (iPad...), computer & smartphone control pages (browser-based; no apps needed).
 - Incorporate cost-effective wired, knob & touch screen remotes (no PoE or Dante license needed).
- Rane's HAL wall plate audio & control remotes solve problems Ethernet and Dante cannot — for less money.

Example using a Dante network with the EXP2x, console, microphones and amplifiers.

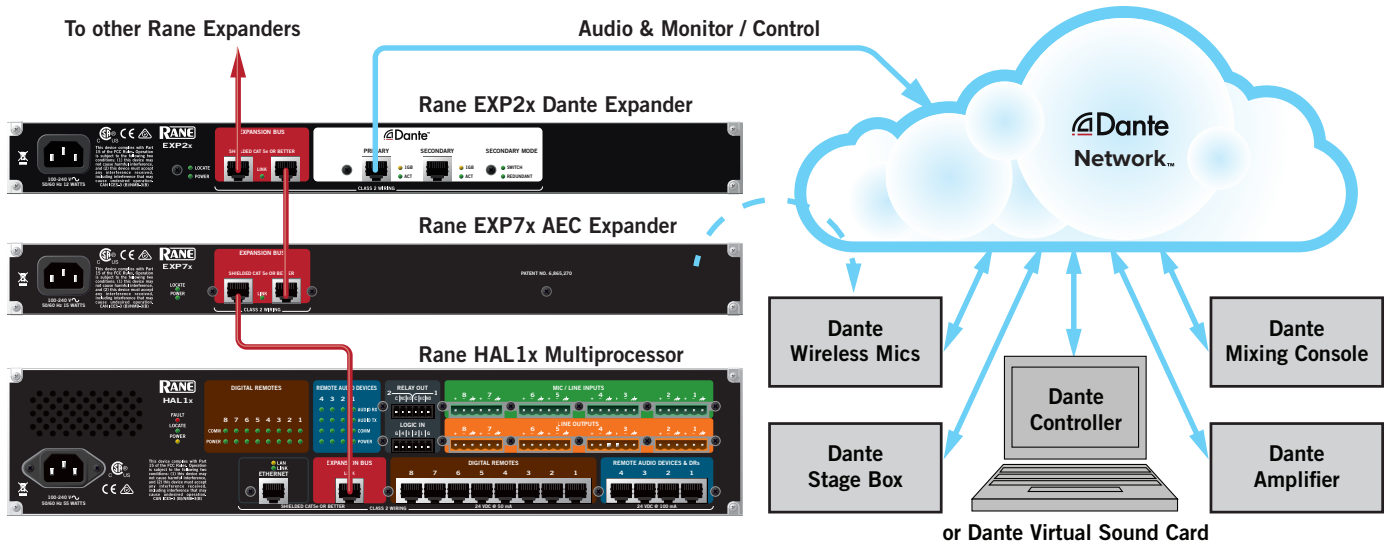

A Rane HAL system supplies DSP for distribution and sound reinforcement, while adding AEC to Dante wireless mics. This is an excellent way to add AEC to Shure's Dante products.

Example connecting 2 HAL systems through the EXP2x

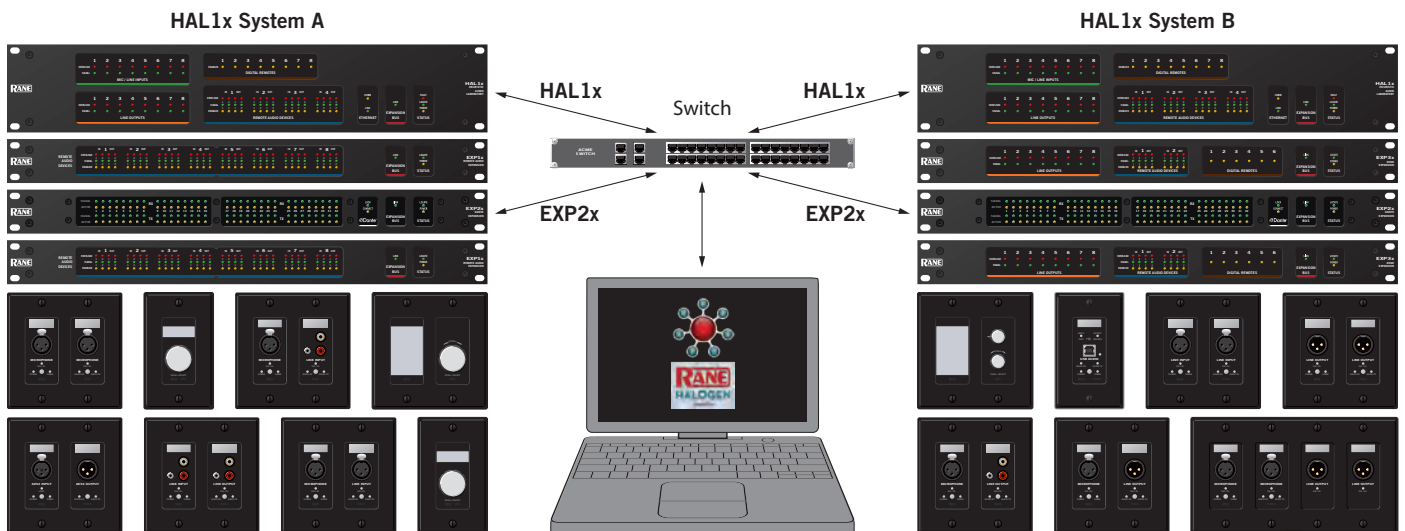

EXP2x Expanders allow two independent HAL systems to share audio channels through an Ethernet switch.

Example using a Dante network with HAL in an auditorium system.

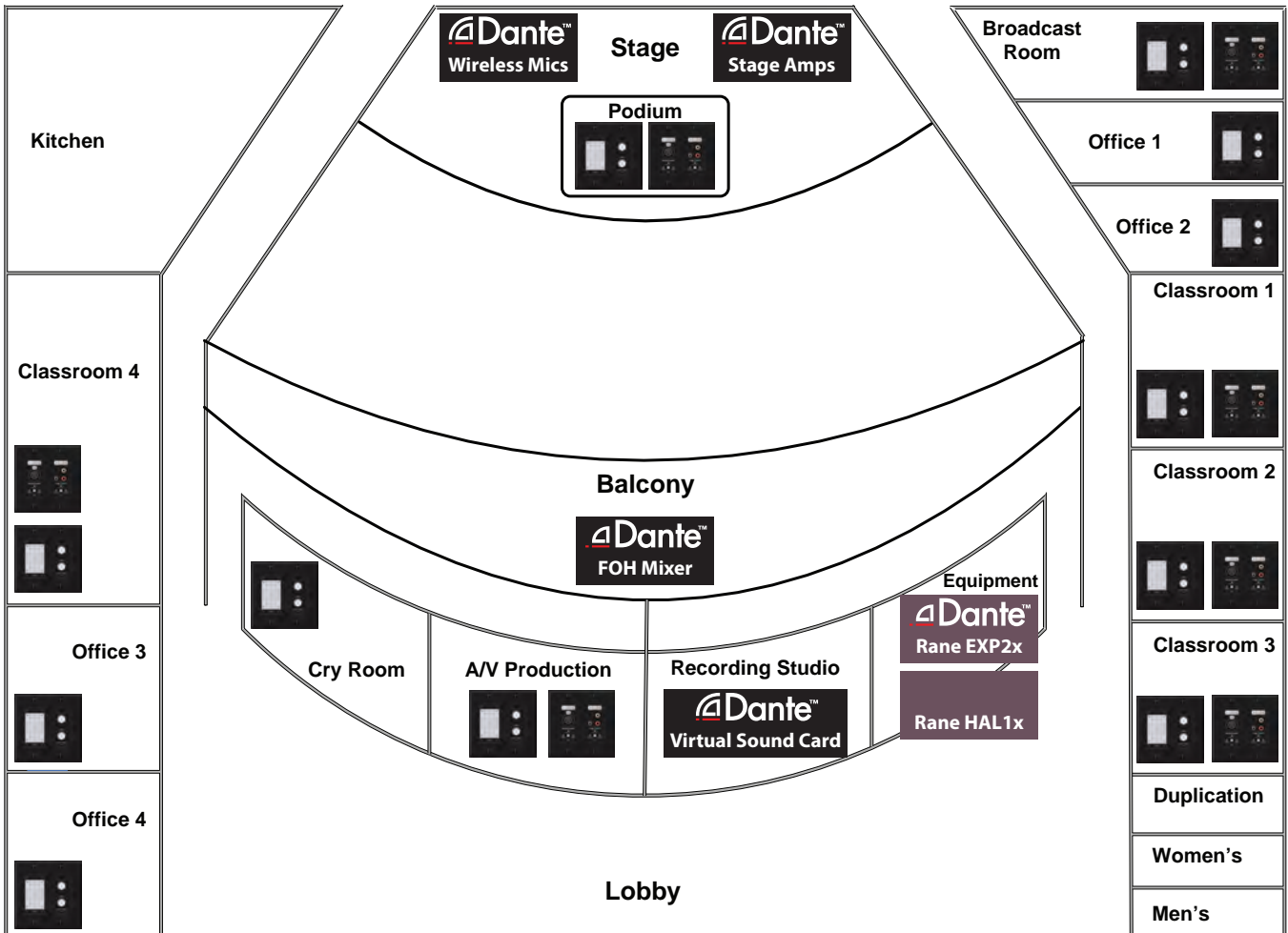
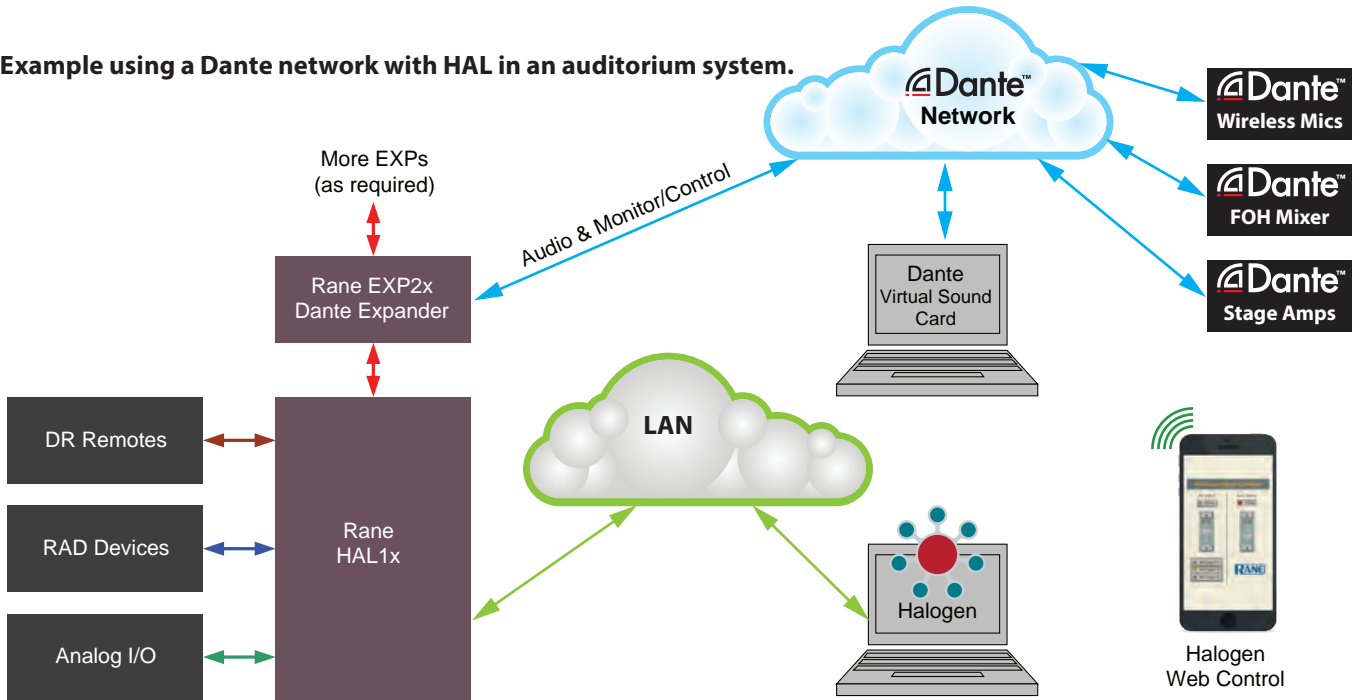



EXP3x Zone Output Expander

The EXP3x is an 8-channel analog output & DSP expander for the HAL1x, which is required for operation. It has 8 logic outputs, 6 DR remote ports and 2 RAD ports making a 4-input, 12-output audio device, depending on which 2 RADs are connected. Thus, 32 daisy-chained EXP3x Expanders provide 256 discrete zone outputs maximum, including output compression, parametric EQ, two levels of paging and background music. These 32 EXP3x Expanders would also provide 64 RAD ports, 192 DR ports and 256 logic outputs.

The dedicated DSP for each of the 8 analog outputs offers two signal processing choices independently selectable per output. When you need background music, paging and emergency paging on an output, select the Zone Output processing set. This provides a Zone Processor block, an Emergency Zone in addition to a Compressor and a 5-band parametric EQ with high- and low-cut filters. When Line Output is selected, the compressor and parametric EQ are available without the zone processing and emergency paging blocks.

EXP3x Application Example

Each EXP3x provides full support for an 8-zone cluster without consuming the HAL1x DSP resources. All of the DSP required for paging, distributed background music selection, PEQ, dynamics and Level control is handled by the EXP3x. DR and RAD resources also scale with 6 DR ports and 2 RAD ports.

The logic outputs on the EXP3x are suited for legacy paging systems where relays within each zone's 70/100 volt volume controls must be tripped during a page. Simply link the Logic Out to a Page Active in the Halogen Paging Manager, and use a Logic Out to drive a relay. This turns up the remote's volume during pages. With 8 logic outputs, 8 zones of old-school constant-voltage paging are supported.

Pushing the EXP3x Zone Output Expander

If your application requires 8 floors of combined retail and office space, where each floor contains 8 zones, the EXP3x is a clear winner with a HAL1x. This would support 64 zones, a handful of building-wide global background music channels connected to the HAL1x directly, paging via PAGER1s within individual or even across a few floors, plus a couple of local-only audio sources per floor. Add up to 58 DR remotes, one or two RADs per floor, and you're done. You can even spread the EXP3x Expanders across different equipment rooms using dedicated shielded CAT 5e cable runs, as long as they don't exceed 100 meters each (300 feet). Use standard unmanaged Ethernet Gigabit Media Converters within the daisy-chained Expansion Bus to achieve distances up to 12 kilometers, or 7.5 miles.

In existing room combine facilities, the EXP3x slots ahead of the amplifiers to upgrade existing systems.

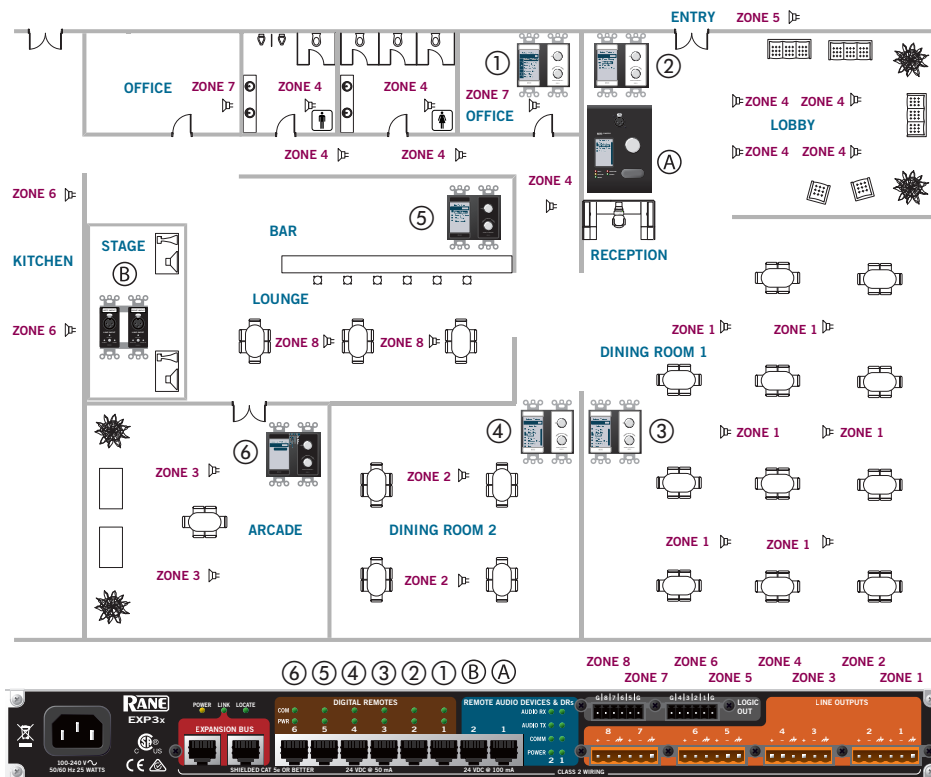



EXP5x Input Expander

The EXP5x is a 12 Mic/Line/Line-Plus input & DSP expander for the HAL1x. It also supplies four DR ports, useful for adding source selection and/or volume control remotes such as the DR3. Each of the 12 inputs independently supports either dynamic mic, 48V phantom mic, +4 dBu line-level, or Rane's Line-Plus input. Line-Plus accepts -10 dBV unbalanced Left/Right Monoed together on the "+" and "-" ports, respectively. For stereo unbalanced sources, Line-Plus allows connecting the stereo RCA left tip conductor to the "+" terminal, the RCA right tip to the "-" terminal, and both RCA shields to the EXP5x Euroblock ground. Select Line-Plus in Halogen and you get a properly monoed audio channel.

EXP5x Application Example

The EXP5x is perfectly suited to expand a HAL1x's analog audio inputs. Control is also expanded given its 4 DR ports. Each of the 12 inputs can independently accept mic, line, or Line-Plus audio — the ultimate in flexible input topologies. Also worth noting is the performance enhancement achieved since the mic input topologies automatically compensate for the sensitivity difference between condenser and dynamic mics.

In a meeting room with ten microphones (see graphic), one audio source (e.g., blu-ray) and a laptop on the podium, all these channels can connect directly to one EXP5x. A single DR3 in the room can select the audio source (blu-ray or laptop) and adjust the room volume. Or, the DR3 can be programmed as a mixer allowing independent level adjustment of all 12 sources in the room: 10 mics, blu-ray and laptop. If the podium location moves from the north to the east wall, duplicate remotes can provide multiple control locations. Use a preset recalled from a switch closure, DR2 remote or 3rd-party Ethernet control system to "spin" the room or disable any DR remote in a room.

There are equipment placement options. If the HAL1x lives in the equipment room, the EXP5x can live in the podium along with the blu-ray, and a single shielded CAT 5e (or better) returns to the HAL1x. However, if you are upgrading an existing facility, the EXP5x connects at the end of the existing analog conduit feeds in one or more equipment rooms.

If you had 12 such meeting rooms, use 12 daisy-chained EXP5x Expanders and a single HAL1x. The accompanying illustration shows only four such rooms. There would be plenty of spare DR ports available for adding control locations. The four

RAD ports on the HAL1x support the addition of page sources (e.g., PAGER1) or portable 8-channel AM2 Automixers. AM mixers can be added to larger rooms - even during a meeting - to add 8 more gain-shared mixed mics to the 10 in any given room. Review the Cascade In feature of the Gain-sharing Auto Mixer or the Room Combine Processing blocks within Halogen for details.

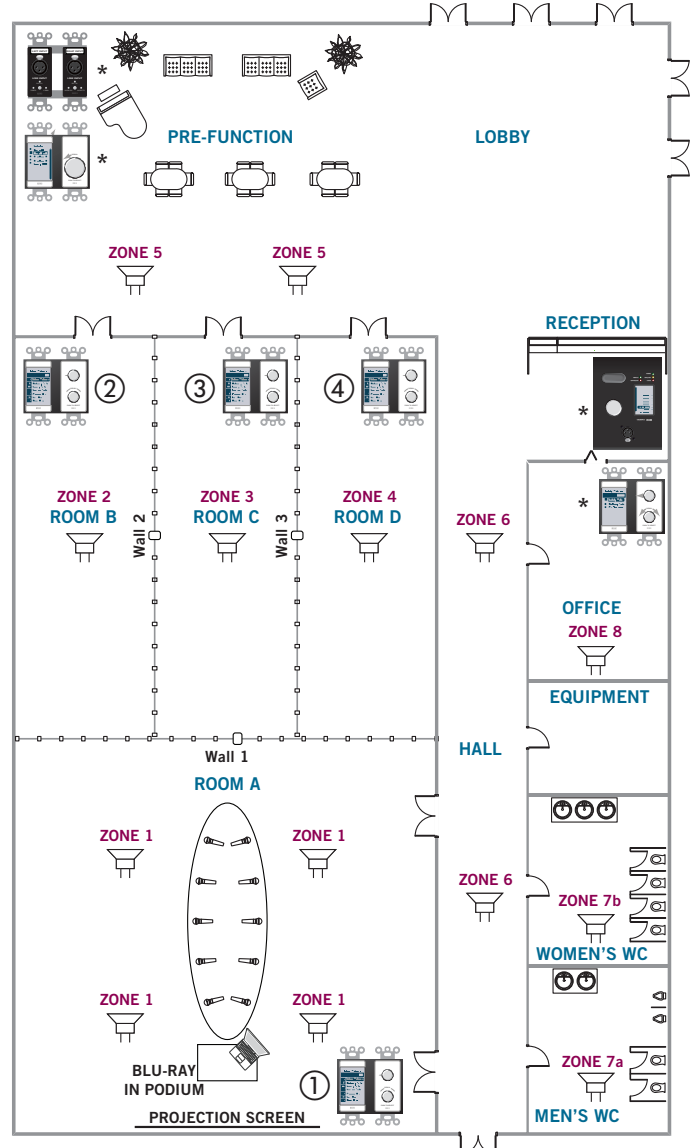



EXP7x AEC Expander

The Rane EXP7x Expander for the HAL1x provides 8 channels of full-featured, drag and drop Acoustic Echo Cancellation (AEC) (U.S. Patent No. 6,865,270). Each channel of AEC can be added to any HAL1x system input and route to any Halogen DSP block, including the gain-sharing automixer, manual mixer, regular Room Combine and Conference Room Combine blocks.

The Rane EXP7x in combination with HAL1x and Halogen software provides a conferencing solution including far more than high-performance AEC. Because EXP7x AEC channels are not associated with a particular hardware input, preset recall can re-assign an AEC resource across inputs / rooms as required. Drag and drop AEC supports the typical one-AEC-per-microphone configuration. With optimum acoustics, mic and loudspeaker placement, or with rarely used mics (such as audience mics) it allows mixing more than one mic into a single AEC channel, significantly reducing cost.



Processing blocks to enhance the AEC system solution:

- Revolutionary Conference Room Combine block with intrinsic support for conferencing.
 - Independent Far End mixers and AEC Reference output per room.
 - Far End gain-sharing mixer inputs and AEC reference feeds automatically change with each room combination.
- Conference Switchboard DSP Router
 - Multichannel and Tracking processing blocks mirror local room processing in the AEC Reference signal path.
 - Included are the Multichannel Shelving Filter, Multichannel PEQ, Tracking Ambient Noise Compensation and Tracking Side-chain Compressor.
- Flexible drag-and-drop AEC placement.
 - Use it where you need it, on any HAL System input.
 - Re-route AEC resources with presets: re-use AEC across rooms.
- Multi-channel processing blocks mirror the room processing in the reference signal path.

Each AEC channel includes:

- Mic and Reference Inputs with Level control & metering.
- AEC on/off, plus adjustable AEC Threshold.
- Soft / loud talker AGC & 5-band parametric EQ, plus high- and low-cut filters.
- Full bandwidth AEC with adjustable non-linear processing.
- Ambient Noise Reduction (dynamic & steady-state) & howling prevention.
- Complete metering: Input, Reference, Echo Return Loss (ERL), Echo Return Loss Enhancement (ERLE) & Total Echo Return Loss (TER).
- 20 to 20 kHz Bandwidth, 300 ms tail length.
- <17 ms propagation delay, 100 dB/sec convergence rate.



Ethernet, RAD and DR Cable Lengths

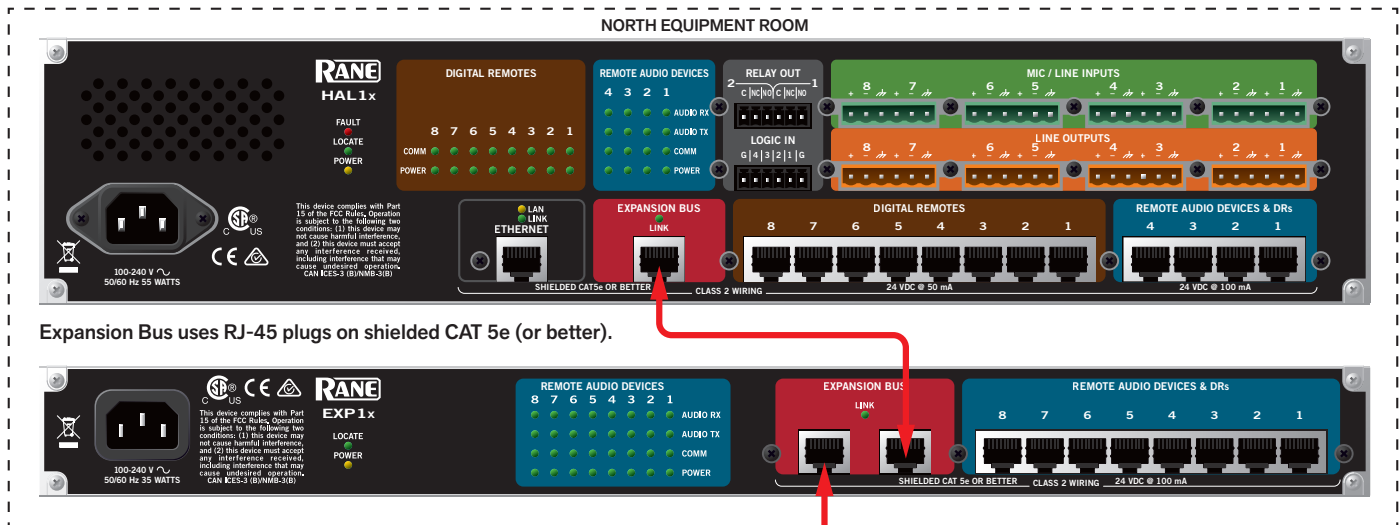
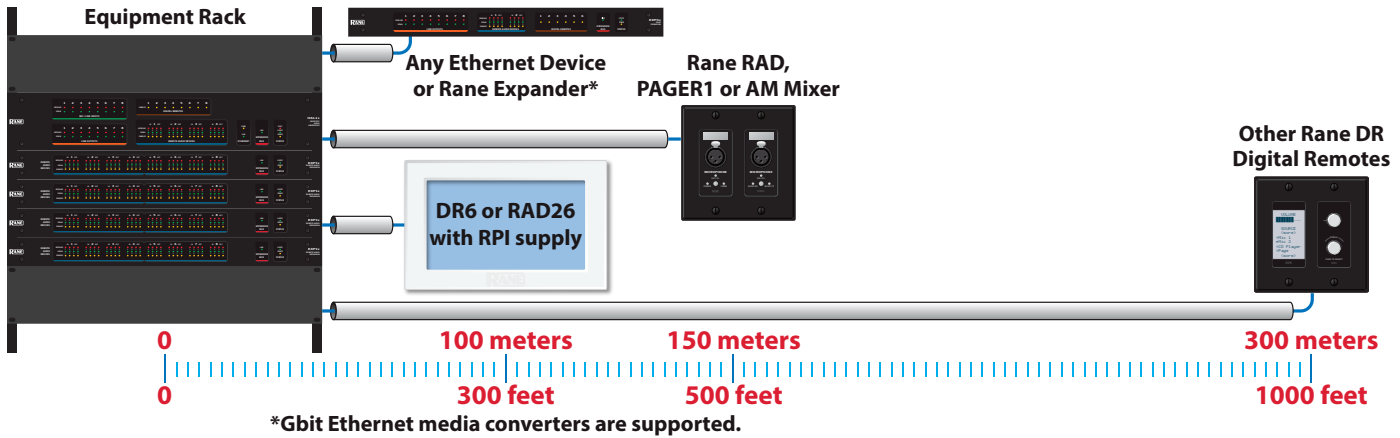

Locate the Expanders up to 100 meters (300 feet) away from each other.
 For greater distance, use off-the-shelf Gigabit media converters:

- Multimode Fiber: up to 2 km (1.2 miles)
- Singlemode Fiber: up to 12 km (7.5 miles)



Shielded CAT 5e (or better) for distances < 300 feet (100 meters)

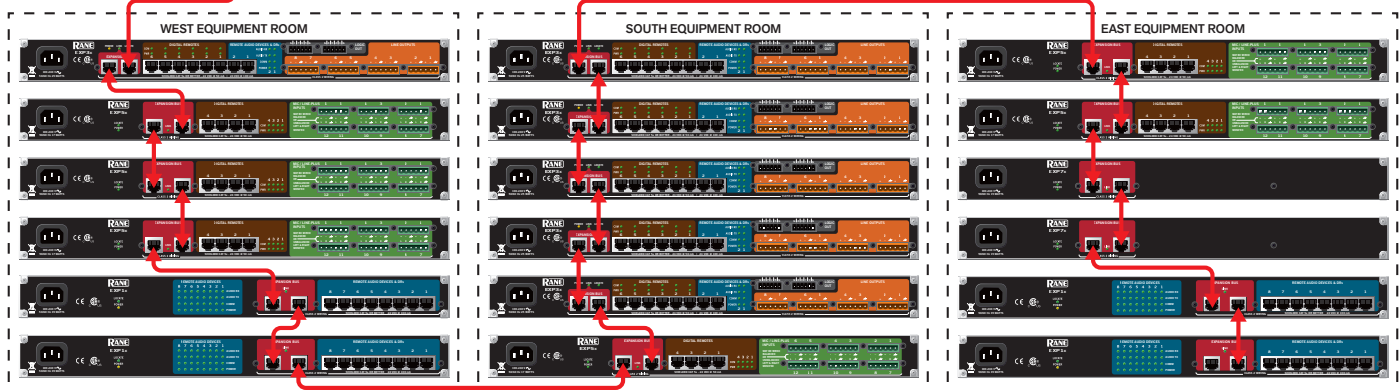

RADs

The entire family of RAD models interface with HAL, for digital conversion at the wall. Each converts analog audio to and/or from 24-bit, 48 kHz digital audio. Shielded CAT 5e (or better) cable and termination transport four digital audio channels – two channels each direction – as well as power, ground and a communications channel, with status indicators at each RAD, HAL or EXP unit, and in Halogen software. HAL auto-checks the CAT 5 crimp and verifies audio. All RADs (and DRs) are both “location-aware” and hot-swappable with 500-foot homerun connections, 66% farther than Ethernet (the RAD26 has a 325-foot limit). Light sensors dim the RAD indicators in dark rooms. Except for the RAD16z, AM1, AM2, and PAGER1, all RADs mount in standard US electrical boxes. Most RADs are available in white, ivory, or black, with a matched Decora® plate cover included.

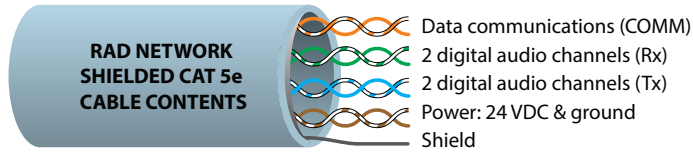

- RAD1** **Dual XLR Mic Inputs**
- RAD2** **XLR Mic Input / Mini & RCA Mono'ed Line Input**
- RAD3** **Dual XLR Line Inputs**
- RAD4** **Dual XLR Line Outputs**
- RAD5** **AES3 Input / AES3 Output**
- RAD6** **Mini & RCA Stereo Line Input / Stereo Line Output**
- RAD7** **XLR Mic Input / XLR Line Input**
- RAD8** **XLR Mic Input / Mini & RCA Stereo Line Output**
- RAD9** **XLR Mic Input / XLR Line Output**
- RAD11** **XLR Mic In / Mini & RCA Mono'ed Line In / Mini & RCA Stereo Line Out**
- RAD12** **Dual XLR Mic Inputs / Dual XLR Line Outputs**
- RAD14** **XLR Mic In / Mini & RCA Mono'ed Line In / Dual XLR Line Out**
- RAD15** **Dual XLR Line Inputs / Dual XLR Line Outputs**
- RAD16z** **Dual Mic-Line-Plus Input / Dual Line Output / Dual Logic / Euroblocks**
- RAD17** **Omnidirectional Boundary Layer Mic (see page 20)**
- RAD18** **XLR Mic Input / 1/4" Balanced Line Input**
- RAD23** **XLR Line Input / XLR Line Output**
- RAD26** **Dual Input / Output / Logic with Level and Source Selection**
- RADX** **RAD Port Extension (CAT 5 wall jack for portable RADs)**
- PAGER1** **Mic Preamp with Push-to-Talk and Page Zone Selection**
- AM1** **Four-Channel Gain-Sharing Automixer with extra Line & USB Inputs**
- AM2** **Eight-Channel Gain-Sharing Cascadable Automixer**

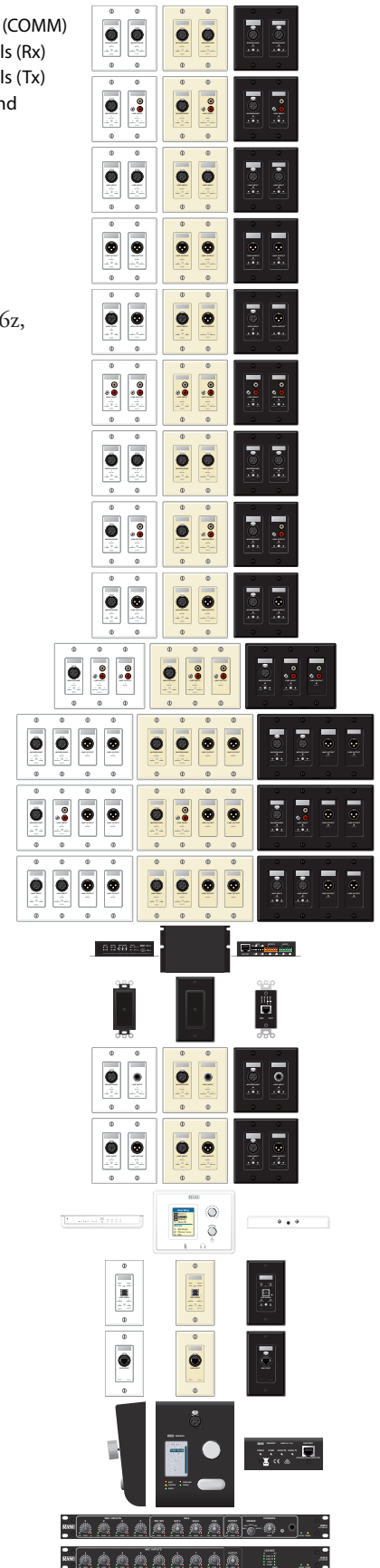

All wallplate RADs are available in white, ivory or black



RAD1 Dual XLR Mic Inputs

RAD1W = white RAD1I = ivory RAD1B = black



RAD4 Dual XLR Line Outputs

RAD4W = white RAD4I = ivory RAD4B = black



RAD2 XLR Mic Input / Mini & RCA Mono'd Line Input

RAD2W = white RAD2I = ivory RAD2B = black



RAD5 AES3 Input / AES3 Output

RAD5W = white RAD5I = ivory RAD5B = black
 The AES3 input accepts sample rates from 32 kHz to 192 kHz. These are converted to the 48 kHz within HAL.



RAD3 Dual XLR Line Inputs

RAD3W = white RAD3I = ivory RAD3B = black



RAD6 Mini & RCA Stereo Line Input / Mini & RCA Stereo Line Output

RAD6W = white RAD6I = ivory RAD6B = black

All wallplate RADs are available in white, ivory or black



RAD7 XLR Mic Input / XLR Line Input

RAD7W = white RAD7I = ivory RAD7B = black

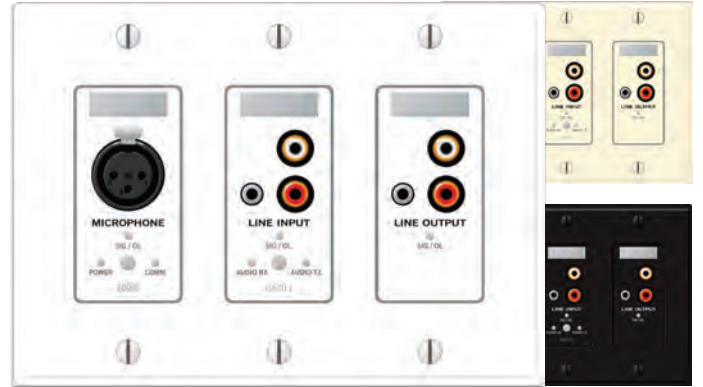

RAD11 XLR Mic Input / Mini & RCA Mono'd Line Input / Mini & RCA Stereo Line Output

RAD11W = white RAD11I = ivory RAD11B = black



RAD8 XLR Mic Input / Mini & RCA Stereo Line Output

RAD8W = white RAD8I = ivory RAD8B = black

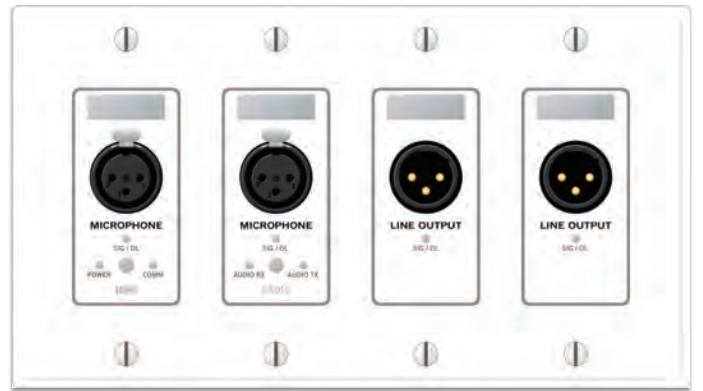

RAD12 Dual XLR Mic Inputs / Dual XLR Line Outputs

RAD12W = white RAD12I = ivory RAD12B = black



RAD9 XLR Mic Input / XLR Line Output

RAD9W = white RAD9I = ivory RAD9B = black

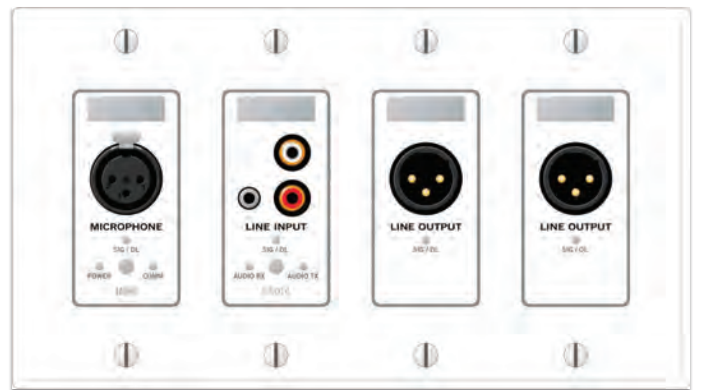

RAD14 XLR Mic Input / Mini & RCA Mono'd Line Input / Dual XLR Line Outputs

RAD14W = white RAD14I = ivory RAD14B = black

All wallplate RADs are available in white, ivory or black

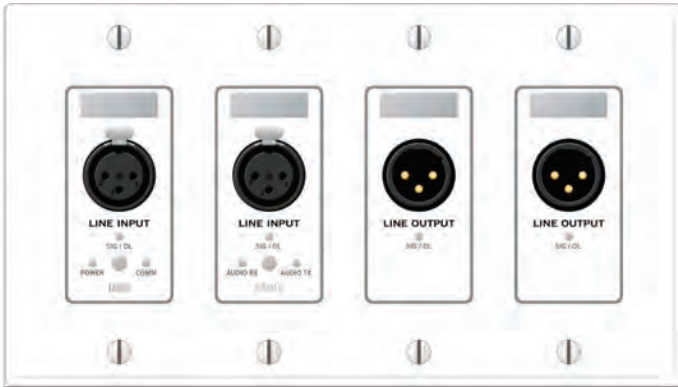

RAD15 Dual XLR Line Inputs / Dual XLR Line Outputs

RAD15W = white RAD15I = ivory RAD15B = black



RAD23 XLR Line Input / XLR Line Output

RAD23W = white RAD23I = ivory RAD23B = black



RAD18 XLR Mic Input / 1/4" Balanced Line Input

RAD18W = white RAD18I = ivory RAD18B = black



RAD27 USB Audio Input & Output Card

RAD27W = white RAD27I = ivory RAD27B = black



RADX RAD Port Extension

RADXW = white RADXI = ivory RADXB = black

Distinguish Ethernet RJ-45 from Audio RJ-45 jacks.



RAD Back and Side View

Euroblock connectors to use if paralleling microphone jacks

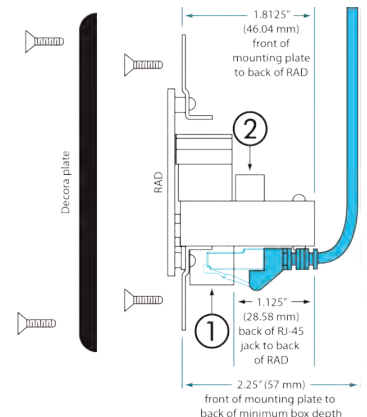
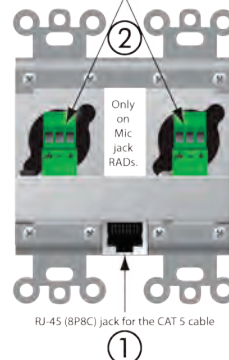

RAD16z Dual Mic-Line-Plus Input / Dual Line Output / Dual Logic I/O

A RAD16z is an alternative to standard switchboxes for impractical areas such as in stage floor pockets or above ceilings. Its form factor is a rugged metal box with flexible surface mounting options. The RAD16z is plenum-rated UL 2043.

It contains two balanced Mic / Line / Line-Plus inputs and two balanced line outputs on Euroblock connectors. Line-Plus allows a stereo unbalanced source to connect to a single balanced input and be mono'ed. Inputs are individually software switchable to Mic, Line or Line-Plus. 24 V phantom power can be enabled in software for a condenser mic.

Two Logic Inputs and Outputs interface other devices to HAL with toggles or commands, like push-to-talk or mute switches, projectors, lights, alarms, etc. Logic In connects a device contact switch between pin 1 or 2 to ground. Logic Out is 5 V high or 0 V low.

Galvanic isolation prevents current flow between the RAD and host technical grounds from interfering with audio. The RAD16z is only available in black.

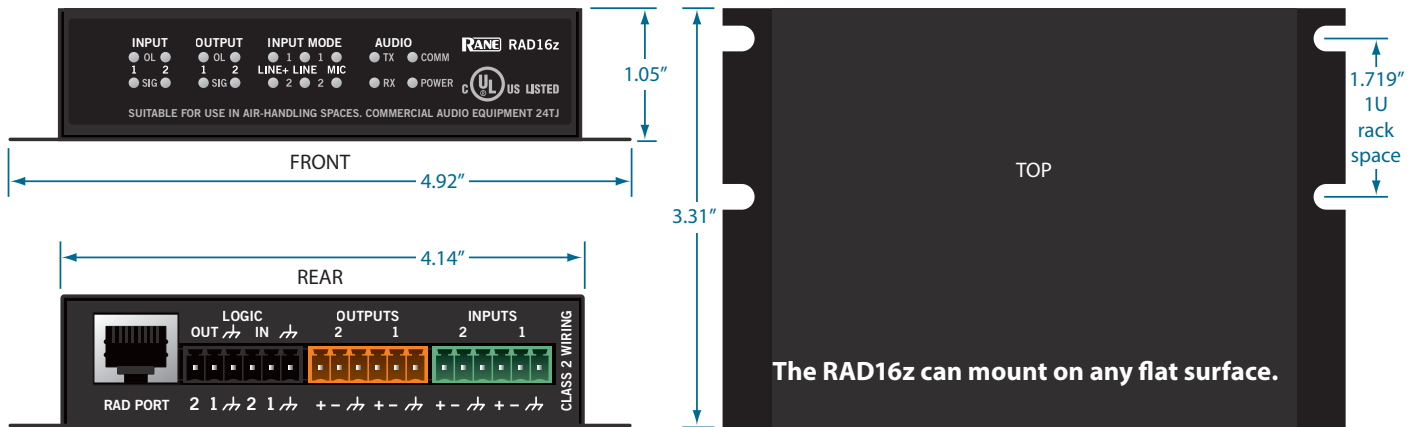

RAD17 Microphone

This omnidirectional boundary layer microphone / PZM pressure zone electret microphone handles extreme temperatures and humidity for indoor or outdoor applications. It may be used for ambient noise sensing, surveillance, security, train stations, etc. Sold only in black, but the grill may be painted any color, and finished with any Decora plate.



AM1 and AM2 Automixers as RADs

AM1 Automixer with 4 Mic/Line Ins, 2 Line Ins, USB Audio I/O, Headphone Amp, and RAD Port.



AM2 Automixer with 8 Mic/Line Inputs and Cascadable RAD Port.



The AM1 and AM2 offer an integrated solution providing superior gain before feedback while eliminating operator error with simple controls. The microphone gain-sharing algorithm automatically and appropriately attenuates mics not in use, while maintaining the 3 dB per doubling of mics for different talkers (noncoherent signals), and 6 dB per doubling for the same talker who is directly between two mics (coherent signals). Think of the person wearing a live lavalier or headset, while approaching a live podium mic... no problem!

The AM2 makes it easy to set up and manage multiple wired or wireless microphones for up to eight participants. More mics are easily handled by daisy-chaining up to seven more AM2 Automixers, supporting up to 64 gain-shared mics.

The AM1 Automixer enables an operator to quickly set up and manage audio for a multimedia presentation involving up to four participants with microphones (wired or wireless) and several program audio sources (e.g., DVD, Laptop and MP3 player). The USB Audio port can simultaneously play back audio and record the AM1's output, so the same laptop can be both a source and a recording device to document meetings, presentations, trainings, and karaoke nights.

The AM1 or AM2 can be a RAD, sending its digital mono output mix to HAL. Once the AM Output mix is in the HAL DSP, additional signal processing such as EQ and compression can be added. Control of the mix's level using Rane's DR1 or DR3 Digital Remotes is a breeze.

AM Automixers may be installed in a mobile case, and connected when needed via an installed RADX on a wall or podium. This allows occasional panel discussions to use as many mics as necessary, while keeping the number of wall plates minimal.

For more details, see the AM1 and AM2 Data Sheets.

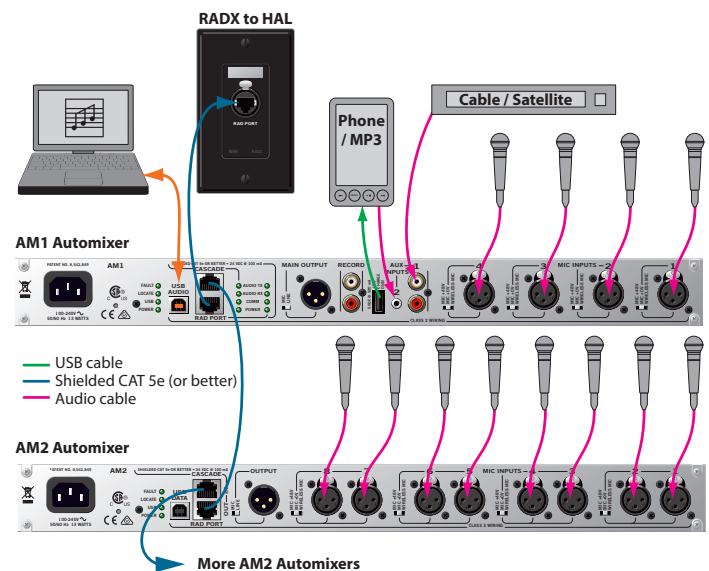

★ **New! RAD26 One Room RAD Remote**

Using one shielded category cable drop, the RAD26 provides any room with a dual 4-watt amp, end user control via a color custom LCD display & encoders, a dual universal audio I/O interface, plus headphone output and line-level input jacks for local needs. Three logic closure inputs and three active-low outputs add to the control capabilities. The amplifier permits a single channel option at 8 watts into 8Ω. Applications include:

- Presentation source and volume, projector and screen control.
- Meeting room with A/V teleconferencing and speakers.
- Spa with BGM, local music input and stereo ceiling speakers.
- Hotel or cruise ship room TV and local input sound system.

A RAD26 provides enough I/O and control to support one room in a HAL audio system which may require these features:

- Local audio line input (smartphone, laptop, MP3, DVD)
- One or two microphone or line-level inputs
- Amplifier outputs for ceiling speakers
- Level control
- Source selection.

Each RAD26 may be installed onto a standard US 2-gang electrical box, 1-gang electrical box, or flush-mounted to a wall surface. The exterior finish is matte white.

Source and level behave like a DR3 remote, but with any combination of Levels, Toggles, Selections or Commands.

On the back there are 2 balanced Euroblock Mic / Line / Line-Plus audio inputs with the mode set in Halogen software. The Line-Plus inputs accept unbalanced left and right signals and sums them to mono. 24V phantom power is available for condenser mics. For end users, there is a 3.5 mm Aux input on the underside of the front, accepting the output of a smartphone, laptop or other consumer device.

A built-in 4-watt stereo amplifier powers a small stereo pair of room speakers, or this amp can be switched in software to power a single 8-watt speaker. Balanced line outputs can drive an external amplifier or powered subwoofer for more output.

Software logic senses an inserted connector at the Aux In or Headphone jacks to optionally override the rear connections.

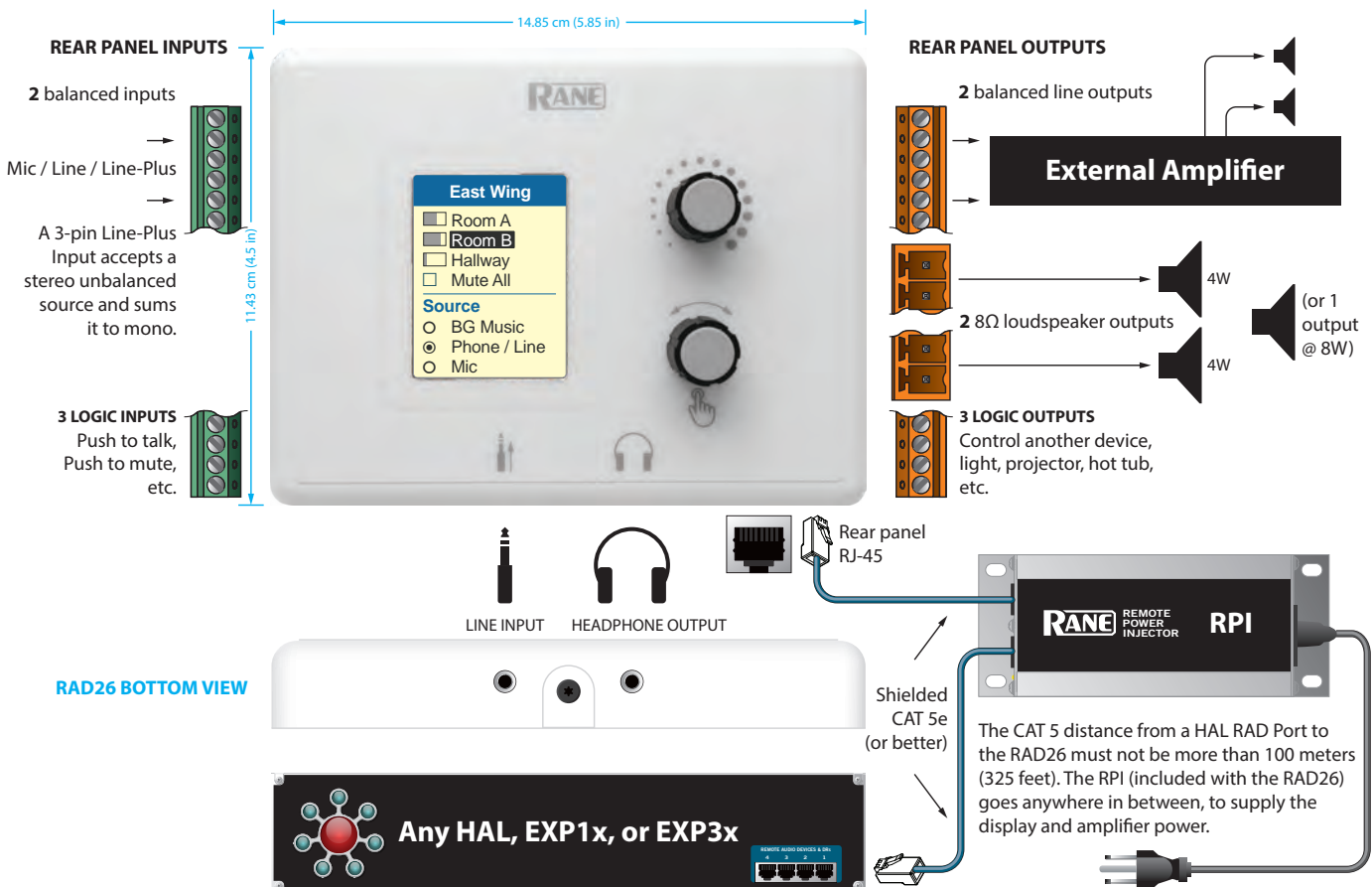
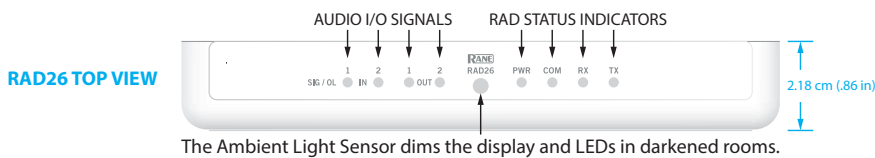

RAD26 Cry Room Application



Crying babies in houses of worship often retire – with mom in tow – to a parent’s lounge or cry room to avoid prolonged worship service interruption. An overhead loudspeaker or two in the lounge can be driven directly from the RAD26 rear panel. The RAD26’s interface permits parents to easily select sources from the rack room such as Sanctuary audio, soothing music, or the prerequisite Baby Mozart channel.

Program the RAD26 Aux input logic in Halo-gen so plugging in a cell phone automatically selects and overrides what’s currently selected. Now mom can play her favorite tunes. The LCD screen can also be programmed to add a new item to the display that shows that the “Local Audio Input” is selected for listening and adjustment.

In slightly large lounges where small meetings are held, place an XLR mic jack below the RAD26 to enable a portable microphone to run the meeting.

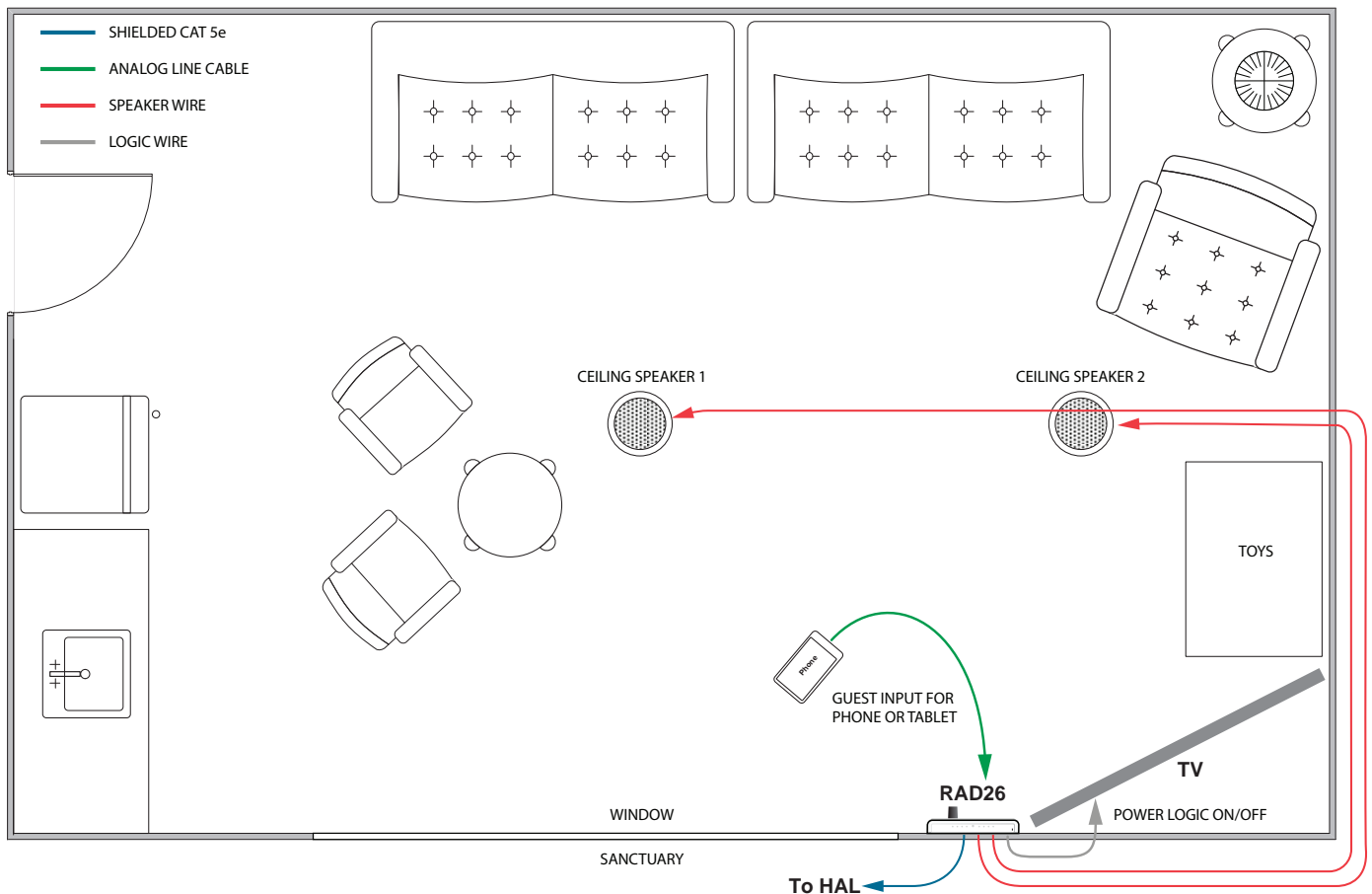

RAD26 Meeting or Classroom Application

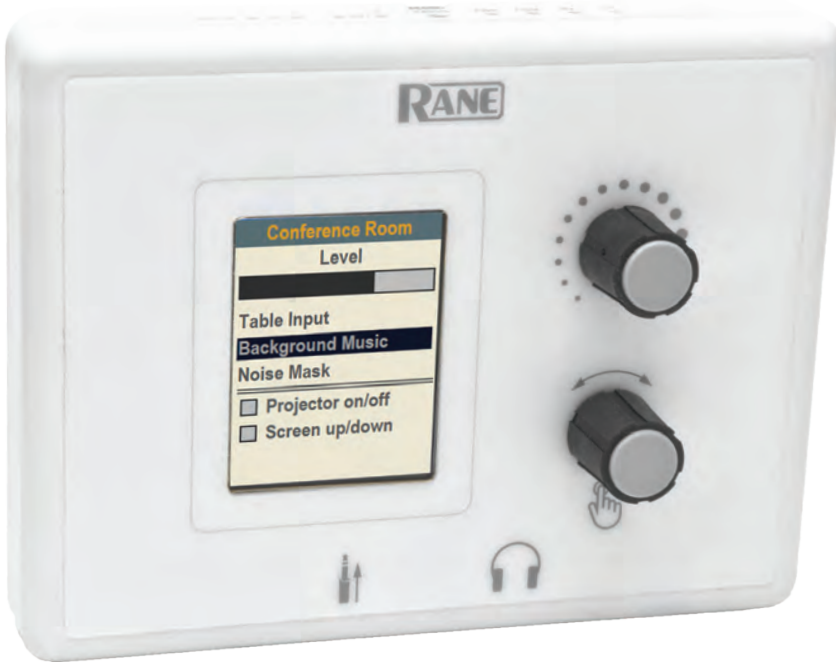

This configuration works for presentations in both boardrooms and classrooms.

The mic connects to the rear of the RAD26. It can be from a ceiling mic, or from a handheld or lavalier wireless mic, with 24V phantom power available for condenser mics.

A presenter can easily plug a laptop, tablet or smartphone into the sound system. A regular consumer cable with stereo 3.5 mm line plugs will work.

When no plug is present, background music or noise masking is available, sent from a HAL multiprocessor elsewhere in the building. A RAD26 selection decides which source, and how loud.

The amplifier is set to dual 4 watt mode to drive the left and right speakers.

The logic outputs can be configured as toggle controls to move the motorized screen up and down, and turn the projector on and off.

HAL lets you page into this room, ducking the local audio, or overriding it — automatically.

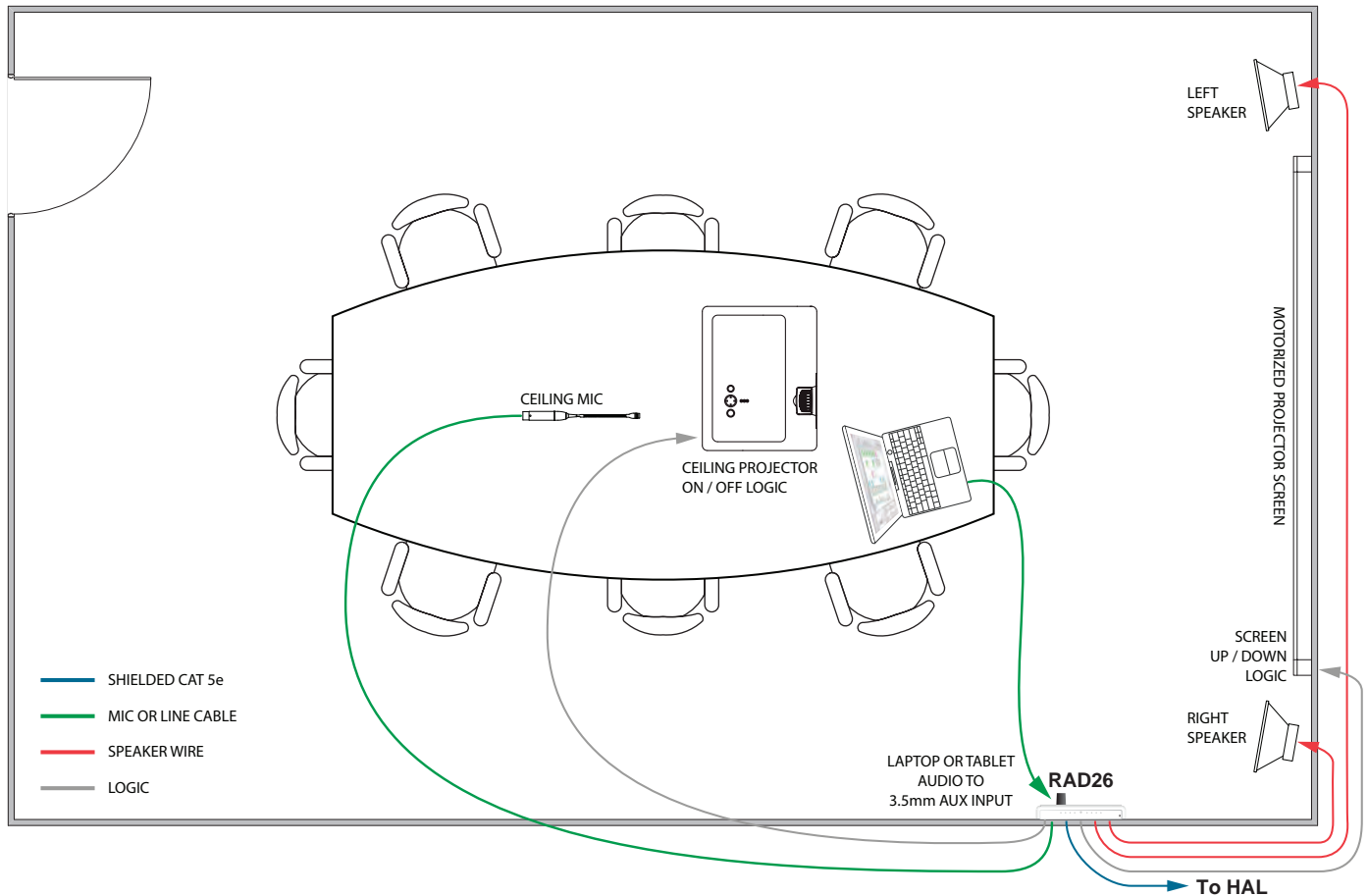

RAD26 Massage Studio Application



This configuration provides a masseuse with easy and intuitive selection of either local or central background music sources and volume.

A desktop computer can supply audio to the rear of the RAD26 as a local background music source.

A masseuse can easily bring in a laptop, tablet, or smartphone connecting via a regular consumer stereo 3.5 mm cable to the AUX input. The RAD 26 can be configured so that inserting an AUX plug can override another music source.

Background music can be sent from a HAL multiprocessor elsewhere in the building. Emergency pages are always available and will override a local music selection.

The amplifier is set to dual 4 watt mode to drive the left and right speakers above the table.

You can add extra bass by connecting a line output to a powered subwoofer.

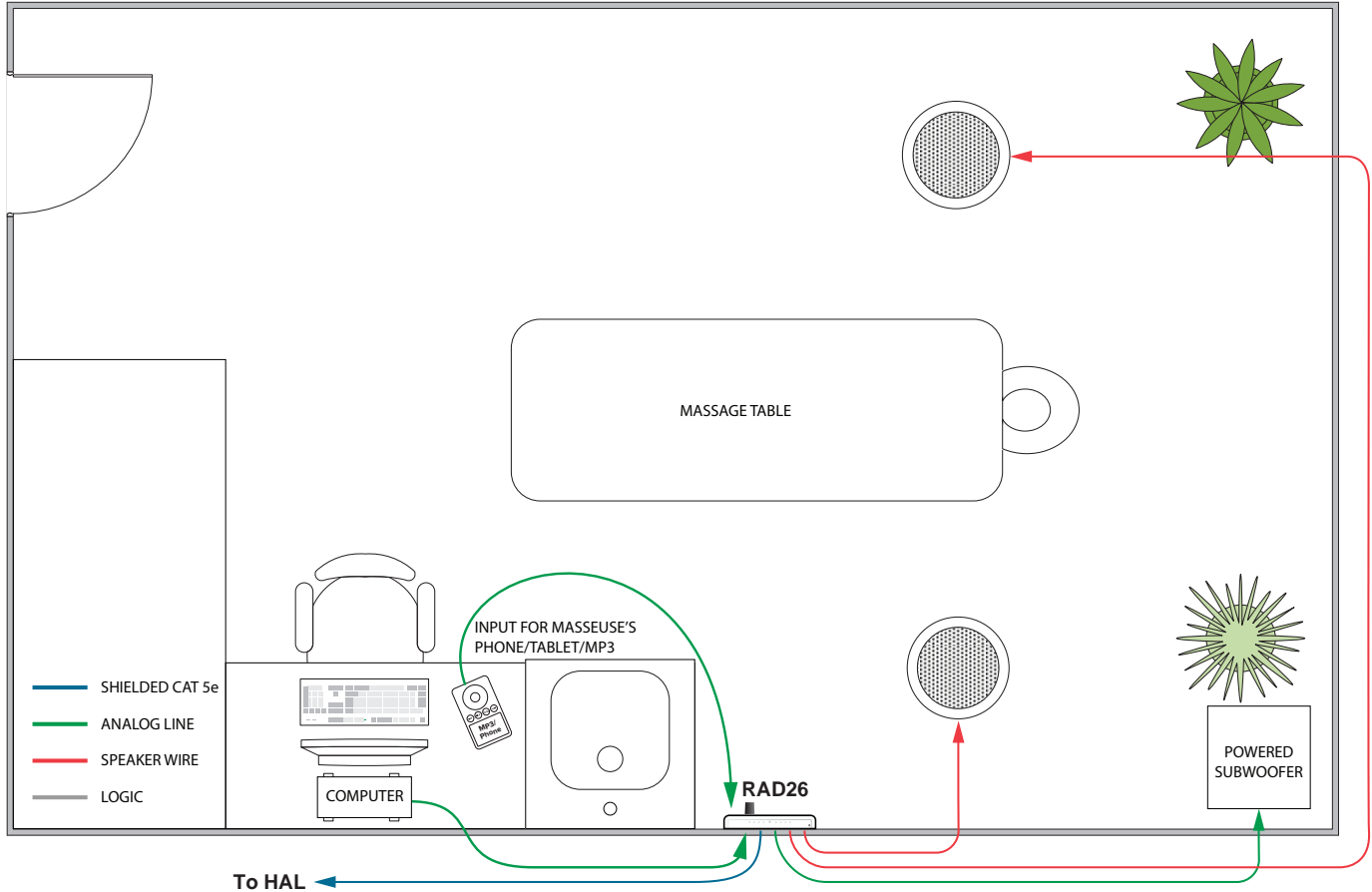

RAD26 Block Diagram

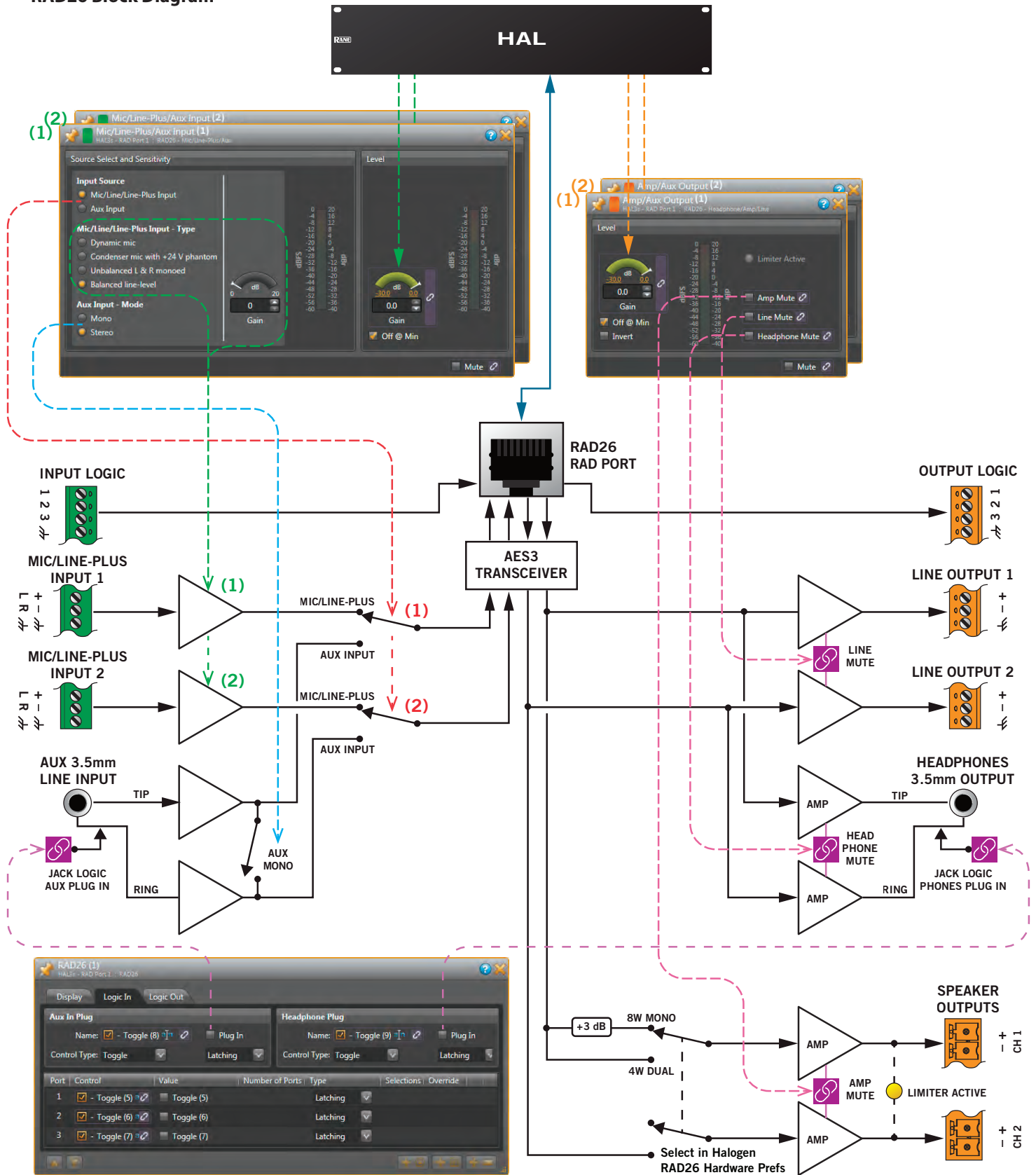

RAD26 Rear Panel (attaches to wall mount bracket)

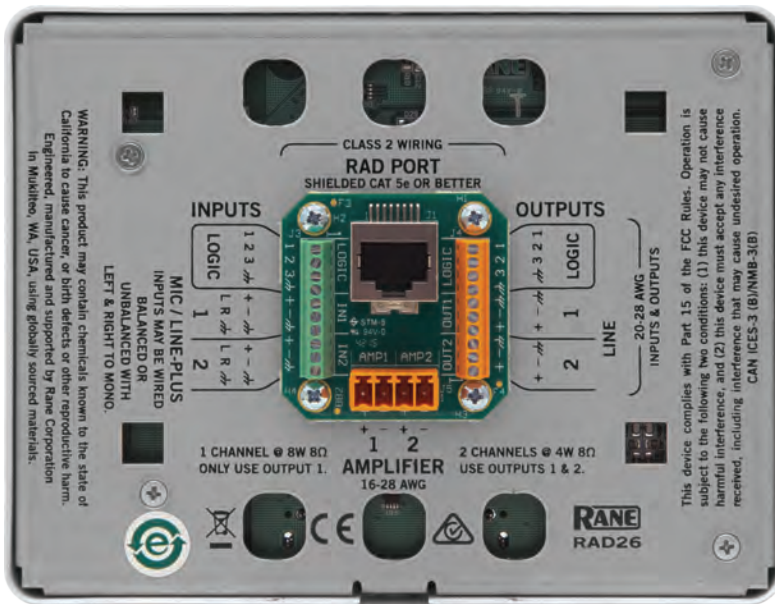

RAD26 Rear Wall Mount Bracket (included)

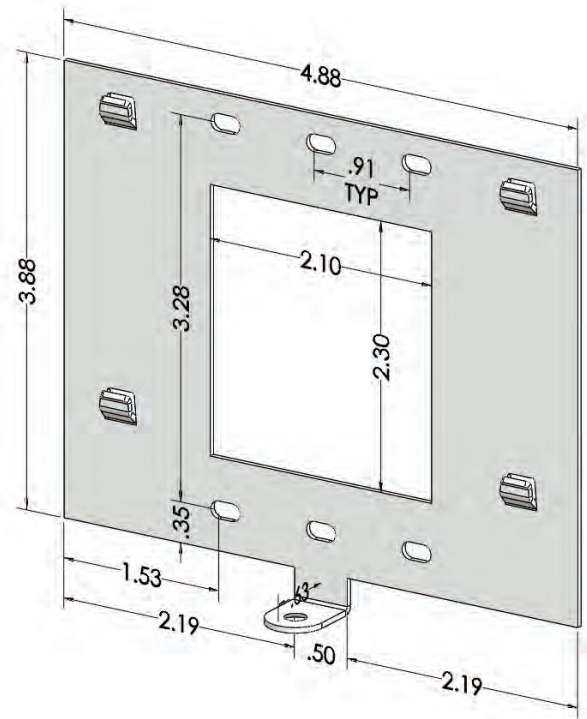

Includes RPI (Remote Power Injector)

The included midspan power injector (not PoE) connects shielded CAT 5e (or better) cables between any HAL and the RAD26 to deliver communications and the extra power needed for the display and amplifiers. The RPI is inserted anywhere between the HAL and the RAD26, which can be up to 100 meters (325 feet) apart. An IEC power cable is included.

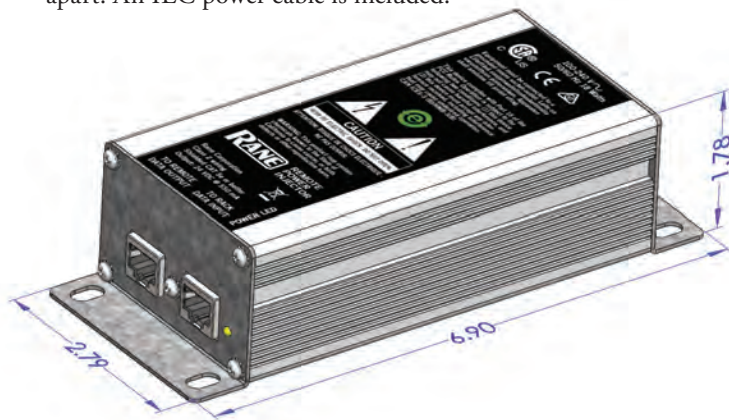

Optional RB2 Rack Mount Accessory

The RAD26 and a round 4" speaker can mount in a 19" rack using this 3U high black-painted metal panel.



RAD26 Applications

Hotels with small meeting rooms and spa rooms require local inputs and control, but must also receive paging or music from elsewhere in the building. Many offices and campuses provide meeting and conference rooms for small groups with in-room A/V presentations, but must also receive emergency announcements. Other RADs and DRs can provide these functions, but require more than one CAT 5 cable. The RAD26 provides all the features required in a single RAD.

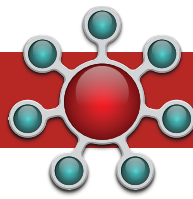

Halogen Software

The Halogen software application is your home for designing, configuring, and controlling your HAL audio system. Halogen's easy-to-use graphic user interface simplifies the design and configuration process so much that your only concern will be deciding how to use the extra time you have!

The Halogen software manages global tasks such as discovering, connecting to, and applying configurations to HAL devices. The interface is divided into two main sections: the Hardware Workspace and the Processing Workspace. Halogen helps you choose the best HAL Model to start a new configuration.

Choose HAL Model for new configuration

HAL Model	Inputs	Outputs	Ports
HAL1x	8 Mic/Line	8 Line	4 RAD, 8 DR, 4 Logic In, 2 Relay Out, 1 EXP (RJ-45)
HAL2	8 Mic/Line, 2 AES3	8 Line, 2 AES3	4 RAD, 4 DR, 4 IR, 4 Logic In, 2 Relay Out
HAL3	2 Line-Plus	6 Line	1 RAD, 3 DR, 4 Logic In
HAL3s	2 Mic/Line-Plus	6 Line	2 RAD, 2 DR, 4 Logic In
HAL4	2 Mic/Line-Plus	2 Line	1 DR



HAL3s

Input(s): Two - Mic/Line-Plus, selectable from software between:
 Dynamic mic (Euro)
 Condenser mic with 48 V phantom power (Euro)
 Two consumer unbalanced L & R monoed (Euro)
 One balanced line-level (Euro)

Output(s): Six - balanced line-level (Euro)

Ports: Two - Remote Audio Device (RJ-45)
 Two - Digital Remote (RJ-45)
 Four - Logic In (Euro)

Form Factor: 1U rack mount

Hardware Workspace

Specify and configure the physical hardware components of your audio system. Troubleshooting messages are easy to spot.



The screenshot shows the 'Hardware Workspace' for a '3rd Floor HAL1x' unit. On the left, a sidebar lists available devices: EXPs (EXP1x, EXP2x, EXP3x, EXP5x, EXP7x), RADs (RAD1 through RAD27), and DRs (DR1 through DR6). The main workspace is divided into three columns: 'Analog Input Ports (Mic/Line)', 'Remote Audio Device Ports', and 'Digital Remote Ports'. Each column has a list of ports with dropdown menus for device selection. The 'Digital Remote Ports' column shows status indicators for each port, such as 'Device Missing', 'Device Incompatible', 'Device Mismatch', and 'Device Unexpected'. The bottom of the screen shows a 'Relay Out' section with two ports.

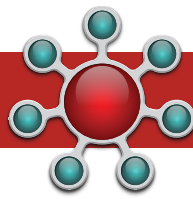

Processing Workspace

Wire together the audio processing components of your system, adding and configuring standard processing blocks such as equalizers, matrix mixers, compressors, limiters, and so on. Manage and configure control links and presets here. Halogen also provides innovative processing blocks that simplify complex multizone background music, paging and room combine scenarios.

Notice that Halogen separates the hardware view from the processing view of your audio system. A key benefit of this separation is the flexibility it provides when configuring the system's various inputs and outputs. For example, suppose you have a RAD2 in your audio system. You drag the RAD2 device into the Hardware Workspace but then go to the Processing Workspace to configure the RAD2's line input and mic input. This separation of hardware from processing allows you to work with each input and output individually instead of having to work with the hardware device as a single entity. It also allows you to focus on hardware in one place and audio flow and processing in another place—simplifying your job as a result. Brilliant!

Workspace Layout

As you may have noticed, the Hardware Workspace and the Processing Workspace have similar layouts. On the right is the actual workspace itself in which you create your system. Associated with each workspace is a palette of objects on the left, and at the top a toolbar specific to the workspace. To add an entity to your audio system, you drag one or more objects from the palette to the workspace.

A simple way to think of the Halogen workspaces is that you use the Hardware Workspace to create, connect and troubleshoot all of your physical hardware, while you use the Processing Workspace to select, configure, and connect the processing blocks and controls.

Wire Management

- Distributed Program Bus
- Paging Manager
- Orthogonal Wires
- Wire Tags
- Highlight Wires

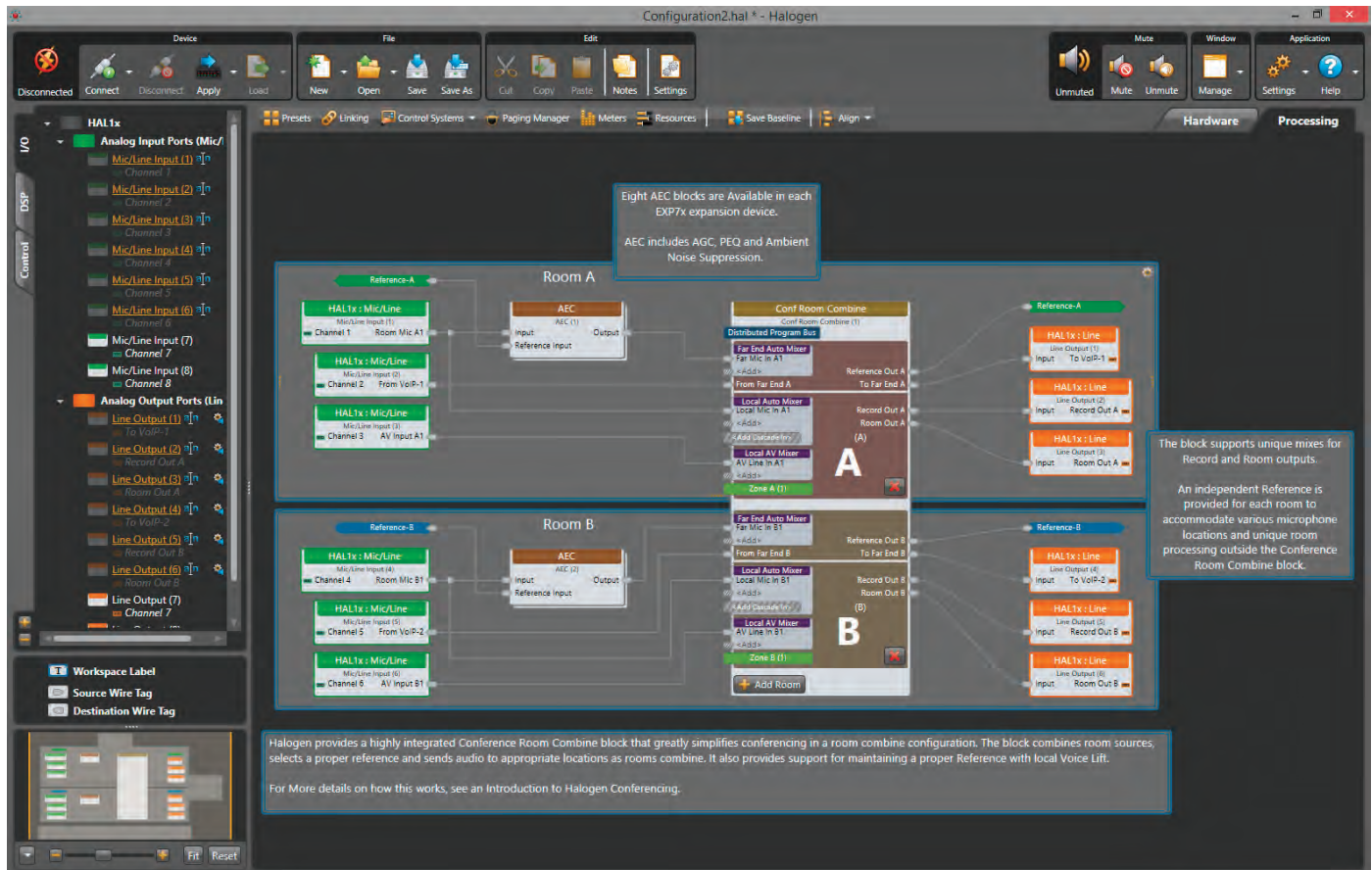

New! Halogen Event Manager



The Event Manager adds a real time clock to any HAL that triggers events using time-of-day. Reset your system every night at midnight. Recall the traditional church service preset each Sunday at 8 AM, and the contemporary preset at 9:40. Or mute all HAL audio at 11:00 PM, then at 11:01 turn off the power amps using HAL's relay or logic output port with your SurgeX — no presets needed.

Each event created can drive either a Toggle, Command or Selector action. Toggle and Selector events support custom start and end times — they have duration. Toggles are displayed as checkboxes. Selectors are two-position radio buttons: event Active or Inactive. Command events are momentary, have no duration, and are useful when recalling consecutive events one after the other. For example, Tuesday Bingo, Wednesday ladies night and Saturday pancake breakfast where no end time is needed.

Events support a variety of recurrence settings such as weekly, daily, specific days, times, or even one-time or manually triggered.

Select the time zone & city for the job site, and HAL automatically adjusts for daylight savings if needed. Set HAL's time manually, sync it to your computer's clock during set up, or when there's an Internet connection on site, point the HAL's clock to an NTP (Network Time Protocol) server. When offline in Halogen, the PC's time zone and clock drive the Event timer, but the HAL's time zone and clock are used when connected live.

An event's value (active or inactive) is read-only and is controlled by the clock's time matching the event's start or end time. Each event offers a linkable enable if your system design requires sometimes skipping events. Each event also has a manual trigger for both active and inactive. Link to these triggers to allow end users or external control systems (AMX/Crestron) to undo an Event that's fired but not needed or already in progress. These manual triggers also permit event troubleshooting and testing and are read-write. This allows linking to DR, HAL web page or 3rd-party TCP/IP controls for end users to manually activate an event in addition to the clock activating the same event. At the same time, triggers automatically driven from the clock also push event values to the linked parameters. This means event indication on web pages, DR remotes and control screen always show event status.

Sort events by name or in time order. During commissioning, temporarily disable all events by suspending the clock entirely. An auto-generated text description of each event helps humans understand what will happen next time the event triggers.

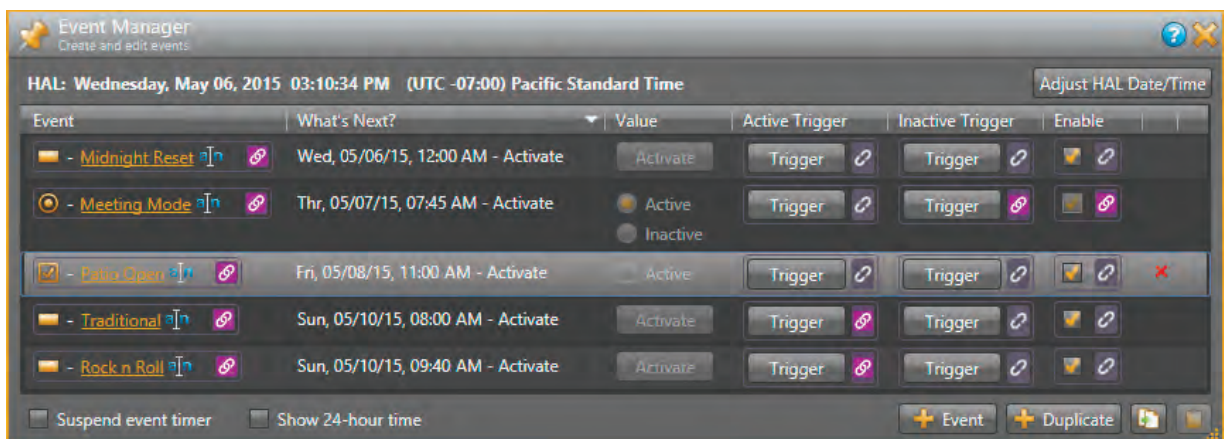
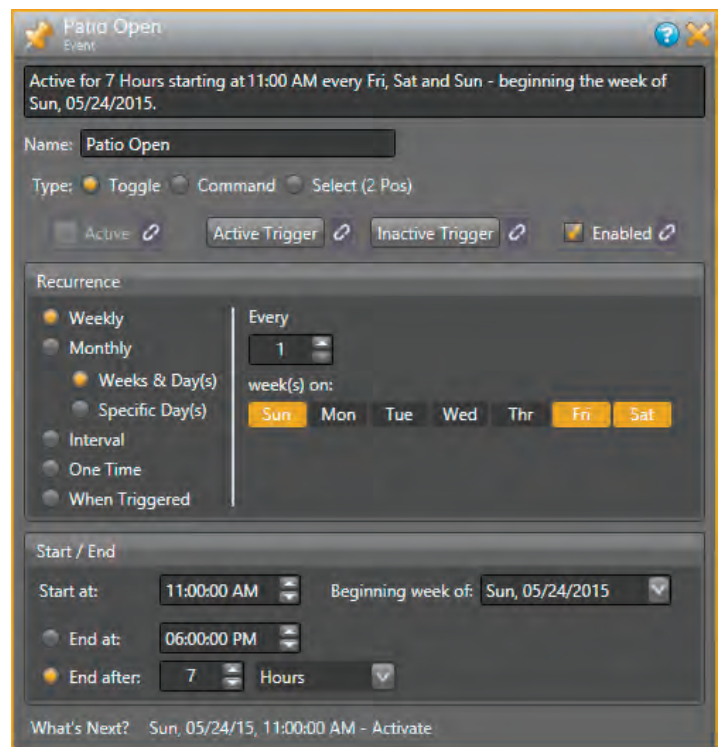

Halogen Processing Blocks

Dynamics

Ambient Noise Compensator (ANC)
Automatic Gain Control (AGC)
Compressor
Ducker
Expander
Gate
Limiter

Misc. blocks

Level
Delay: simple
Delay: distance
Delay: video
Signal Meter
Pink Noise: Simple
Pink Noise: Ramped
Pink Noise: Swept
Sine Wave generator
Voice Detect

Filters

Feedback Suppressor
Cut Filter
Shelf Filter: single
Shelf Filter: multichannel
Parametric EQ: single
Parametric EQ: multichannel
Graphic EQ
FIR Filter
Crossover: 2-way mono
Crossover: 3-way mono
Crossover: 4-way mono
Crossover: 2-way stereo
Crossover: 3-way stereo
Crossover: 4-way stereo
Crossover: all-pass
Crossover: CD horn

Mixers

Mixer: 2 to 80 inputs
Matrix Mixer
Gain-sharing Auto Mixer
Gain-sharing Auto Matrix Mixer

Selectors

Selector: 2 to 80 inputs
Priority Selector
Router: 2 to 80 outputs

Conferencing

(requires EXP7x)
Acoustic Echo Canceling (AEC)
Conference Switchboard
Conference Room Combine
Compressor: Tracking
ANC: Tracking

Paging and Room Combine

Distributed Program Bus
Paging Station with 2-band PEQ, Compressor, Level
Paging Zone
Emergency Page Zone
Zone Processor with Priority Selector, Level, Paging Zone

The Room Combine block contains processors in this order:

- Gain-sharing Auto Mixer for a Mic Input.
- Mixer for a Line input.
- Sum for the Mic and Line Inputs.
- Selector from the Distributed Program Bus.
- Level control.
- Paging Zone.

Digital Remotes

Three Digital Remotes simplify end user control and eliminate installer brain fatigue. Use Digital Remotes for volume control, preset recall, source selection, or resetting or toggling system states. All offer customizable backlit LCD screens for intuitive end user labeling. Home run shielded CAT 5e (or better) connections to a HAL or EXP eliminate addressing, external power, and the need to test the cables.

The **DR1** supports Level Control.

The **DR2** offers Single Selector or List of Toggles/Commands behavior.

The **DR3** has three behaviors: Single Level & List of Toggles/Commands, List of Levels for either multizone volume control and/or input source mixing, and Single Level plus Selector.

DR1 Digital Volume Remote



Level Control

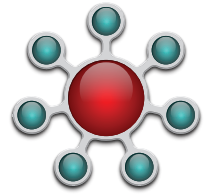
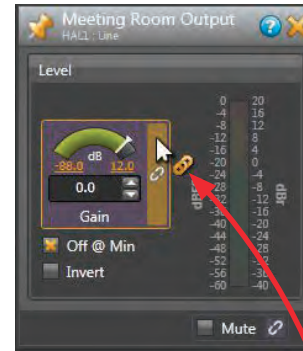

DR2 Digital Selection Remote

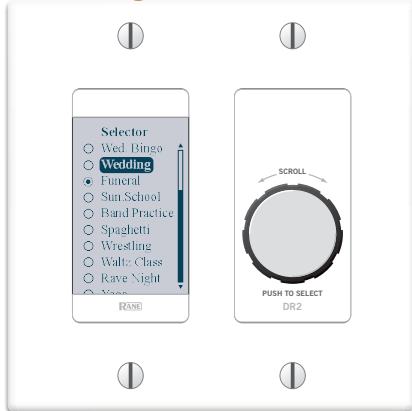

Single Selector



List of Toggles / Commands

Control Linking

Drag the control chain icons atop one another to create links between Levels, Toggles, Selectors, Commands, Digital Remotes, Web Controls and/or 3rd-party controls.

Above, a DR1 Remote links to a Meeting Room Output Level control. Activation and Priorities work together for incredible flexibility. Link simple analog remote level controls, contact closures and IR remote wall sensors by adding a DR4 Logic I/O Expander.



DR3 Digital Volume and Selection Remote

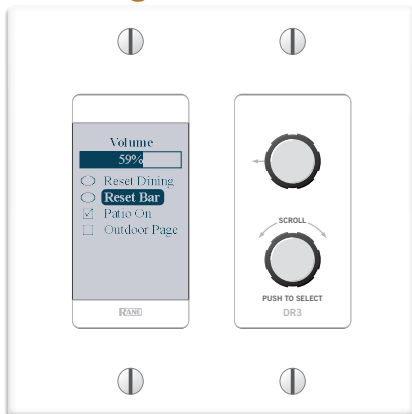

Single Level & List of Toggles / Commands

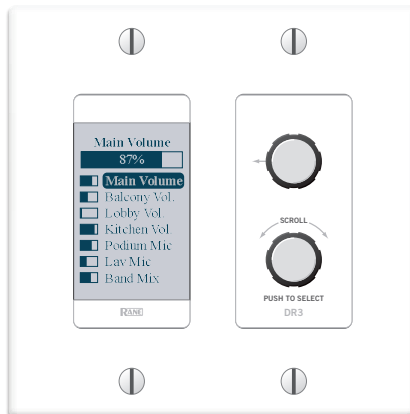

List of Levels

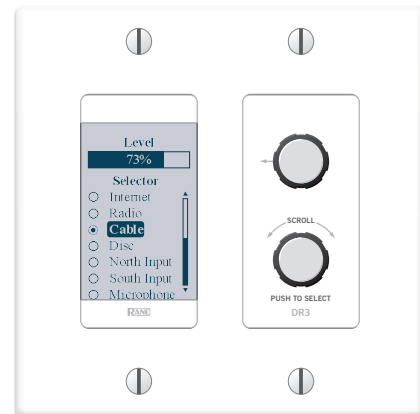

Single Level & Selector

DR4 Logic I/O Expander

The DR4 Digital Remote adds additional logic input and output ports to any HAL, enabling simple analog level and logic I/O controls plus IR2 remotes for wall sensing. The DR4 offers eight logic ins and outs, six IR ports and eight analog input ports for

pot-on-a-wall level control. Multiple DR4's can connect to Digital Remote Ports on any HAL, up to 300 meters (1000 feet) away. See the Logic Inputs, Control Inputs and Logic Outputs on page 36. See the IR2 Infrared Wall Sensors on page 37.



DR5 Switch Controller Remote

The DR5 Digital Remote offers additional logic input and output ports, enabling the use of simple analog switch controls in any HAL system. Lighted switch panels for room combine applications are easily integrated into a HAL system using the eight switch inputs and eight LEDs outputs on the DR5. Unlike the HAL and DR4 Logic I/O, the DR5 Logic Out is intended to drive the LED indicator on a room combine panel, and is a writable parameter. The DR5 is designed to fit in a standard US dual-gang electrical box or mount directly near a room combine panel.

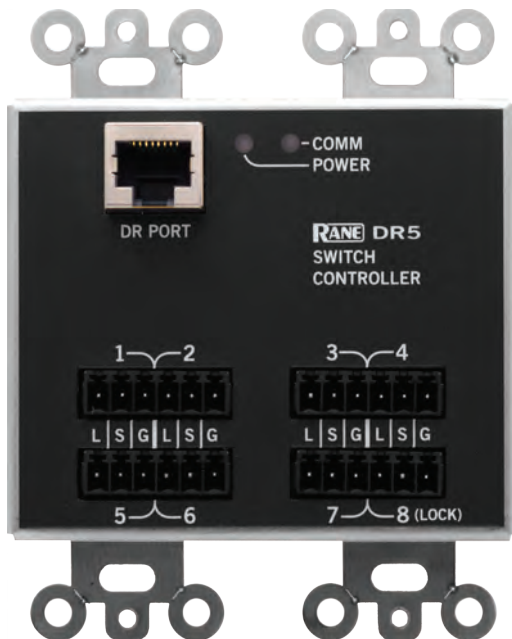
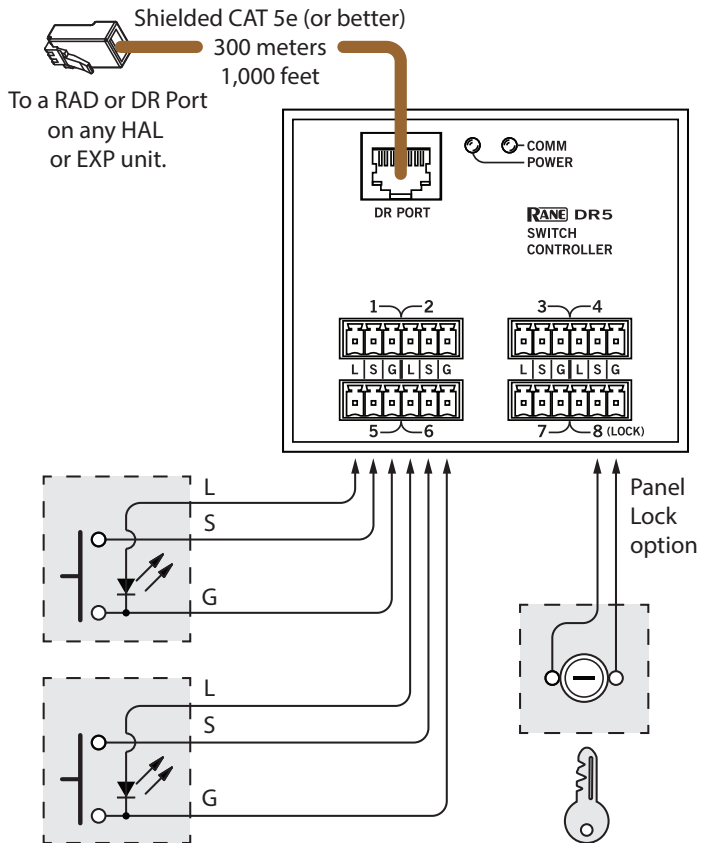

DR6 Touchscreen Remote Control

The new DR6 is a fully customizable touchscreen remote for the HAL family. It supports multiple pages or tabs and any set of levels, toggles, selectors and/or commands. Drag, drop and resize controls any way that's desired. Use custom background images and logos in full-color on the 7-inch LCD display.

Screw the included wall-mount bracket over U.S. or international electrical boxes, or flush mount the $\frac{3}{4}$ " thick DR6 with a 2-inch hole in the wall to accommodate the cable. The optional DS1 desk stand accessory (shown) allows the DR6 to mount on a horizontal surface.

The included midspan power injector connects CAT5e (or better) cables between any HAL and the DR6 to deliver communications and the extra power needed for the display.

Optional, on-screen User Access logins secure management pages from public or staff use, and a programmable ambient light sensor automatically dims the backlight.

The Control Page Designer in Halogen allows you to create one set of pages and use them in a web control design, DR6 display or both.

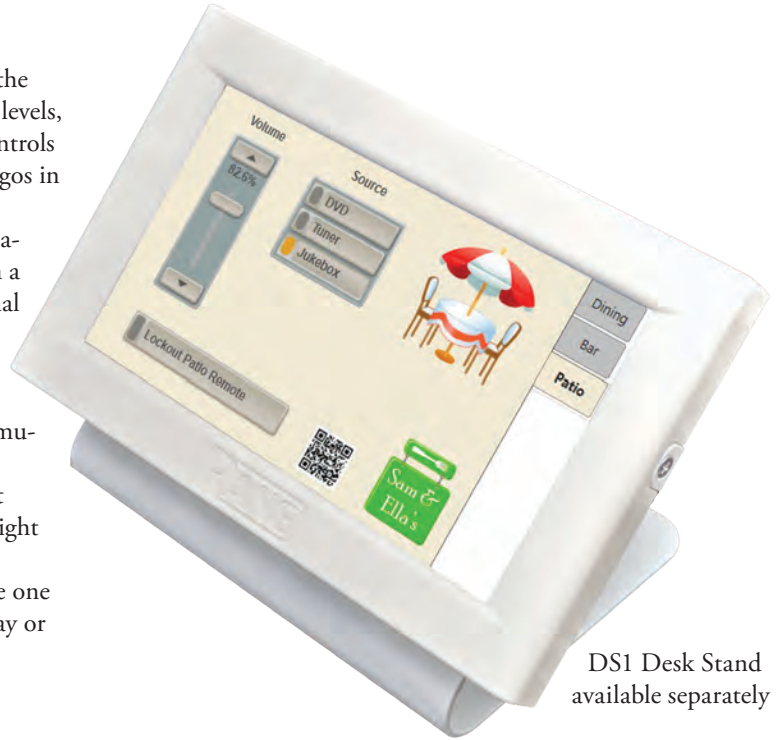

DS1 Desk Stand available separately

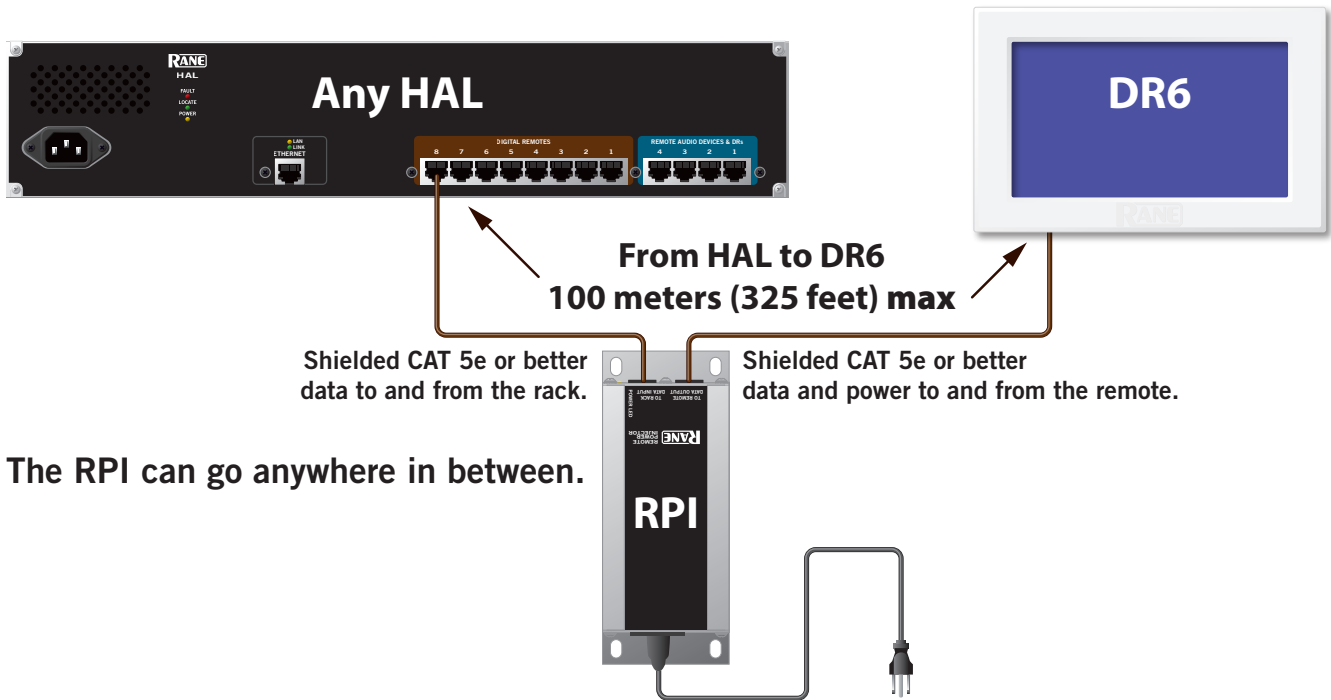

The RPI can go anywhere in between.

Optional DS1 Desk Stand Accessory

- All steel, painted white.
- Rubber bottom protects the desktop.
- Kensington security hole.
- Holes in the bottom to fasten to a desktop.
- Larger hole in bottom to thread CAT 5 cable through the desktop.

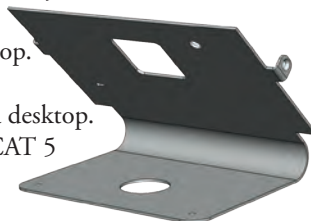

Optional RB2 Rack Mount Accessory

The DR6 and a round 4" speaker can mount in a 19" rack using this 3U high black-painted metal panel.

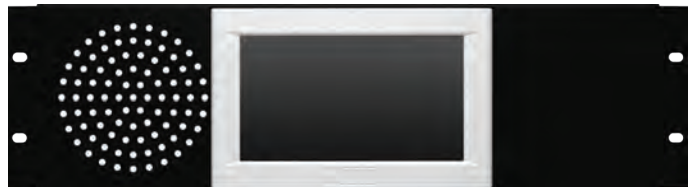

Halogen Web Controls

Control the Levels, Selectors, Toggles and Commands in any HAL System from **any device with a web browser**. Halogen's Web Controls feature allows creation of custom HTML GUI control screens. Define the quantity of control pages, and the layout, labeling and size of each control, and completely test them using your default web browser from within Halogen.

Access any control page from any browser-enabled device on the network with a HAL device. Just open a browser and type in the customizable IP/webpage address for the HTML page – and bookmark it for easy access. Type in an optional User Access code, and voilà, the trick, she is done! Control your HAL system wirelessly from one or more tablets, smart phones, laptops or desktop computers. The HAL web server is multi-client, allowing control across many devices and many rooms. You can link Rane's wired DR remote controls (DR1, DR2, DR3, DR6 and RAD26) and wireless devices and they'll automatically track each other.

Customers are asking for "iPad control" and Halogen's Web Controls is the solution. It is not Apple®-centric — no iTunes® store or app installs required. We save a lot of ink on this page not listing all the possible devices that support web browsers and wireless Ethernet.

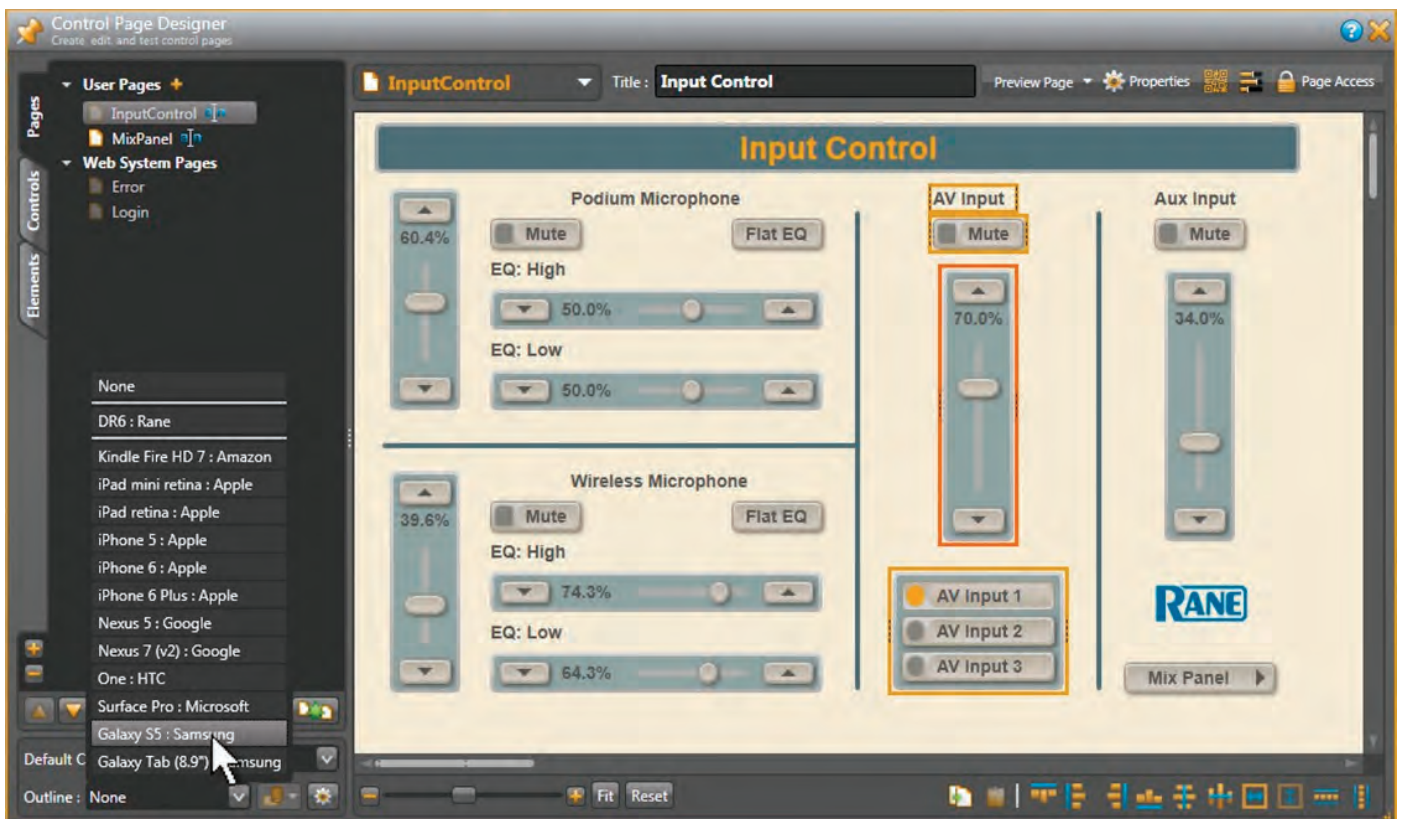
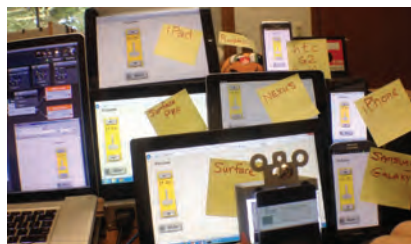

Logic Inputs

These inputs are found on the HAL1x, HAL2 and HAL3s. More can be added with the DR4 or DR5 connectable to any HAL. You can configure each of the Logic Input ports in one of three ways: toggle, command, or selector.

The **Toggle** configuration allows a Toggle command with an on/off switch. You can configure each port type to be either *Momentary* or *Latching*.

The **Command** configuration allows triggering a Command control from an on/off switch, which can link to one or more Command controls such as a Command preset or a linkable button in a processing block property dialog.

The **Selector** configuration uses either a multi-position switch or a binary switch. You can connect a physical device to any or all of the Logic In ports and configure the ports in Halogen so they make the desired selection according to the state of the physical device.

Wiring details are in the Halogen Software Help. The Selector configuration is not supported by the DR5.

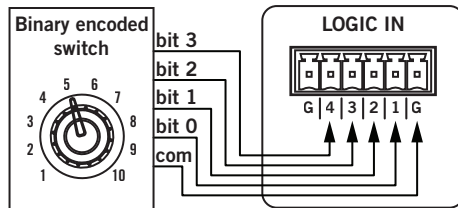
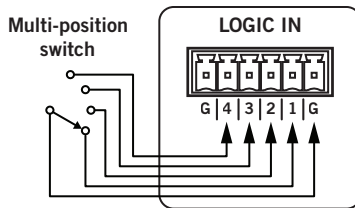
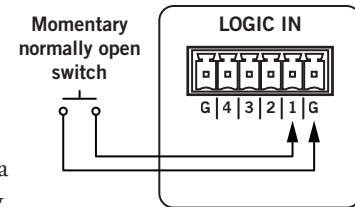

Analog Control Inputs

These inputs are found on the DR4 that can connect to any HAL. Each port allows an analog voltage source to control the value of a Level control in the Halogen Control palette. The input range for the port is from 0 V to 5 V, where 0 V corresponds to 0% on the associated Level control and 5 V corresponds to 100%.

Connect a physical linear-taper potentiometer; the Vc wiper provides the control voltage to the DR4. As you adjust the pot the voltage changes, which in turn changes any linked Level control in Halogen.

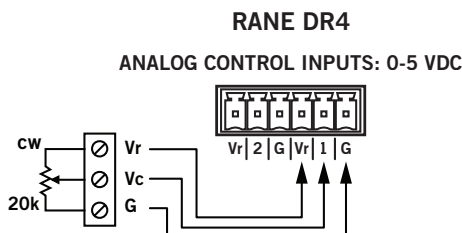

Logic Outputs

These outputs are found on the EXP3x Output Expander for the HAL1x, or on a DR4 that can connect to any HAL. You can configure each of the 8 output ports in one of 2 ways:

- **Toggle:** When a toggle control in the Halogen Control palette is unchecked, HAL sets the corresponding DR4 Logic Out port to logic high (5 V), and when the toggle is checked, it sets the port to logic low (0 V).
- **Selector:** When a selector control in the Halogen Control palette is set to the first selection, HAL sets the corresponding DR4 Logic Out port to logic high (5 V). Conversely, when the selector control is in the second position, HAL sets the port to logic low (0 V).

Relay Outputs

These reed relay ports are found on the HAL1x and HAL2 to signal other devices. A common implementation is to link a relay port to a Toggle control so an end user can change its value. Halogen software contains a checkbox for each relay port. Its value can be included in a preset or link to another control, making it possible to use a preset or control to turn the relay port on or off.

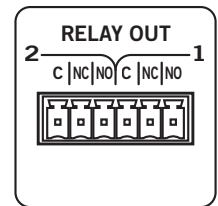

AMX, Crestron and Stardraw Support Packages

These Control System Guides include an introduction to external control systems with HAL. Each appendix includes reference information on the HAL external control message protocol and how to use a telnet client to monitor and troubleshoot control system operation. Each package has an example HAL1x configuration and how to set up a controller for each touch panel to communicate with a Halogen/HAL Control Server.

The Support Packages are installed with the Halogen software and can be accessed from the Windows Start Menu under Rane Corporation > Halogen > Guides > AMX, Crestron or Stardraw.

IR2 Infrared Wall Sensors

The Rane IR2R and IR2S are collectively known as an IR2, working in pairs to provide an automatic way to sense the position of a movable wall or door. The IR2S sends infrared, the IR2R receives it. Mounting brackets and screws are included.

A single shielded CAT 5e (or better) cable for each door connects the IR2 to an IR Remote Port on a HAL2 or a DR4.

When mounted on opposite sides of the wall, green indicators on the IR2R and IR2S are always lit. Only when the door is open and the IR2R is receiving infrared from the sender does the IR2R's amber indicator light. Depending on the IR2 mounting height and your eyeglass prescription, these indicators can usually be viewed from the floor.

For an IR2 remote to control audio, the IR2 requires a connection to a HAL2, or to a DR4 connected to any HAL loaded with a suitable configuration. When doors or movable partitions are opened or closed the IR2 automatically detects this, and the audio system reconfigures itself appropriately and automatically. The IR2 will operate up to 1.5 meters (5 feet) apart.

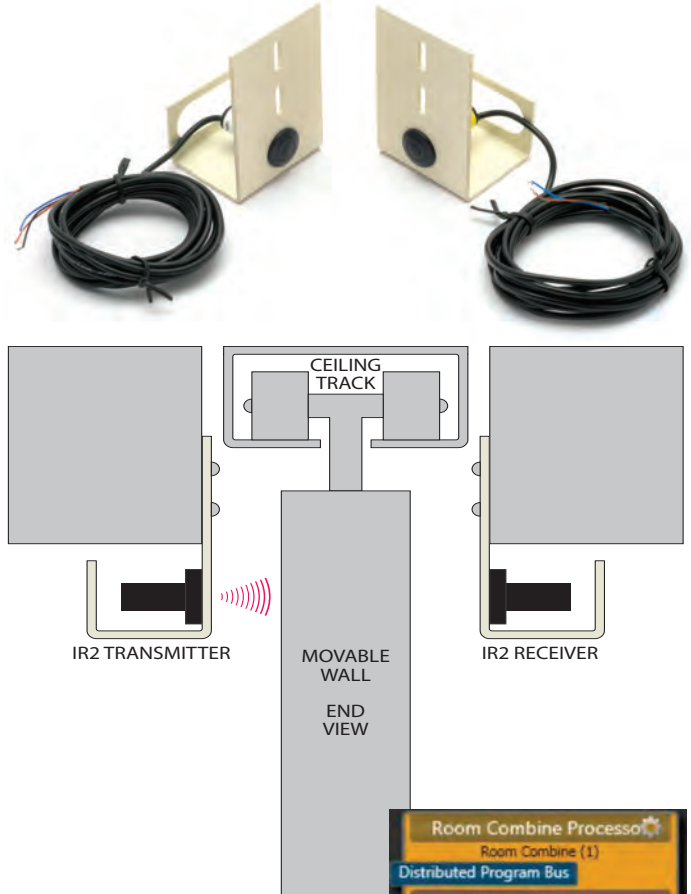

Room Combining with the IR2

Both Room Combine Processors (regular and conferencing) support custom wall layouts and auto-activation of independent room processors for each possible physical room as walls open and close. Control linking between Rane IR2s, Digital Remotes, Web Controls, or 3rd-party controllers to wall open/close toggles and room processing and volumes is exquisitely intuitive, and these combine and separate automatically as wall states change. No presets required. Use Rane AM2 Automixers to gain-share auto-mixed mics in combined rooms and separate the mix automatically as walls close. Gain-share with both in-room mics and wireless mics when cascaded into a HAL's room combine processor. This means AM2 mixers can be hot-swapped between locations for quick setup at head table discussions.



PAGER1 Paging Station

This RAD is a mic preamp with a paging zone(s) [Scenario] selector with integrated push-to-talk switch. Busy, Caution and Ready indicators inform end users when priorities clash. It accepts any standard gooseneck mic (not included) and has built-in selectable 24 V Phantom Power and a 13 dB pad. It normally sits on a desk or table, and has lockdown features for device and microphone security.



Multizone Paging with the PAGER1

DISTRIBUTED PROGRAM BUS

Wiring system-wide background music sources into the single Distributed Program Bus automatically wires all music sources to every output zone — even if there are hundreds of zones and dozens of background music sources. The blue Distributed Program Bus label in the Halogen processing map represents bus output and input to blocks.

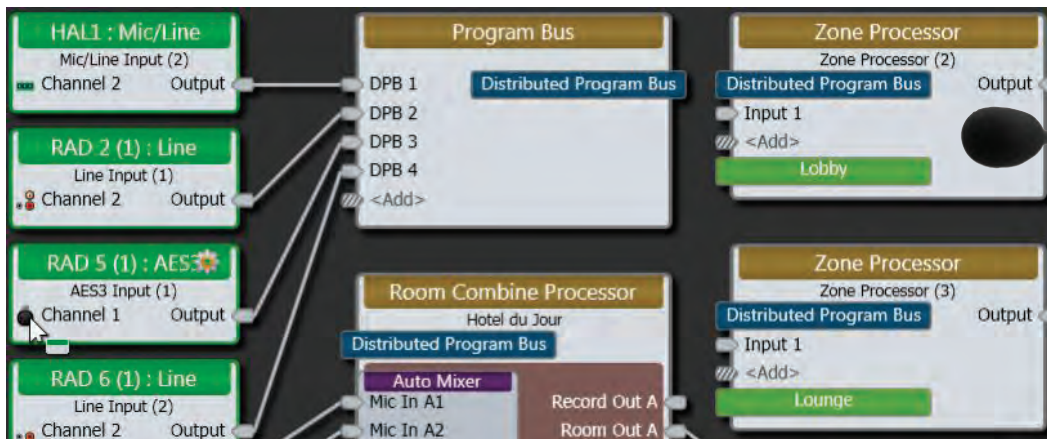

PAGING STATION AND ZONES

Paging Station and PAGER1 input DSP blocks automatically connect input page sources (lime green labels) to zones requiring paging. Thus, wiring from all page sources through the Paging Manager to all page zones – including rooms that combine – is automatic. The Paging Manager easily maps all page sources to any combination of zones when using the Paging Zone, Emergency Page, Zone Processor and Room Combine Processor blocks.



Acoustic Echo Canceling (AEC) with the EXP7x

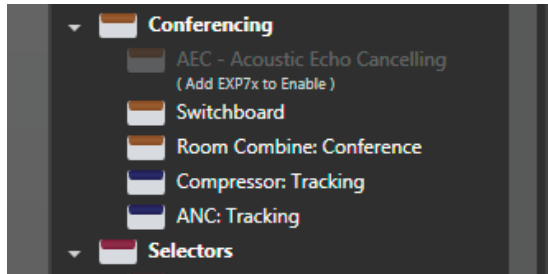

After adding an EXP7x to a HAL1x, new Conferencing blocks are made available in the DSP Processing Tab (above). Now, eight AEC blocks can be placed. When these are all utilized, the AEC Block is grayed out with a hover-tool-tip indicating a need to add another EXP7x to acquire eight more AEC blocks.

AEC Block and Controls (right)

Conferencing Processing Example (below)

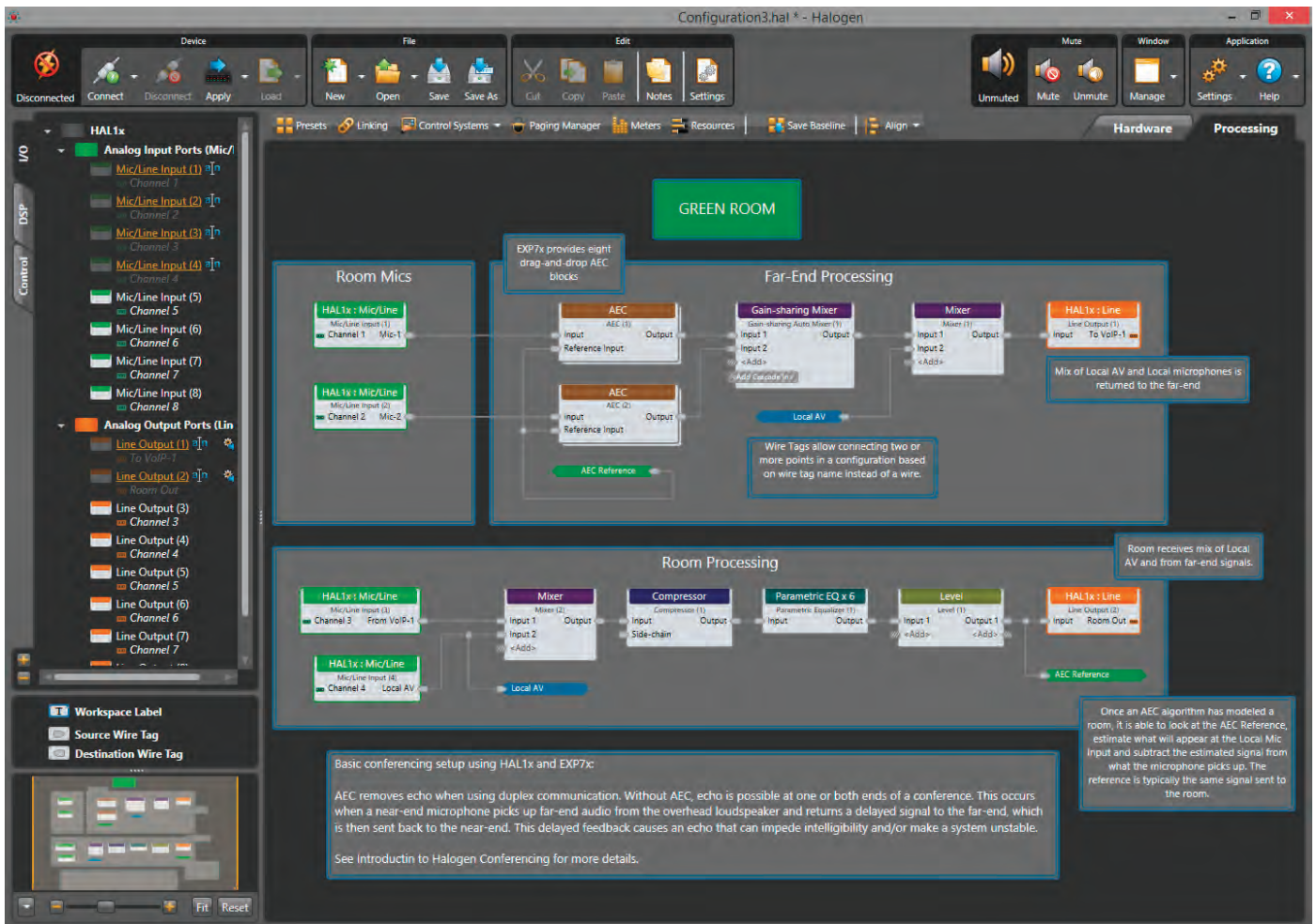

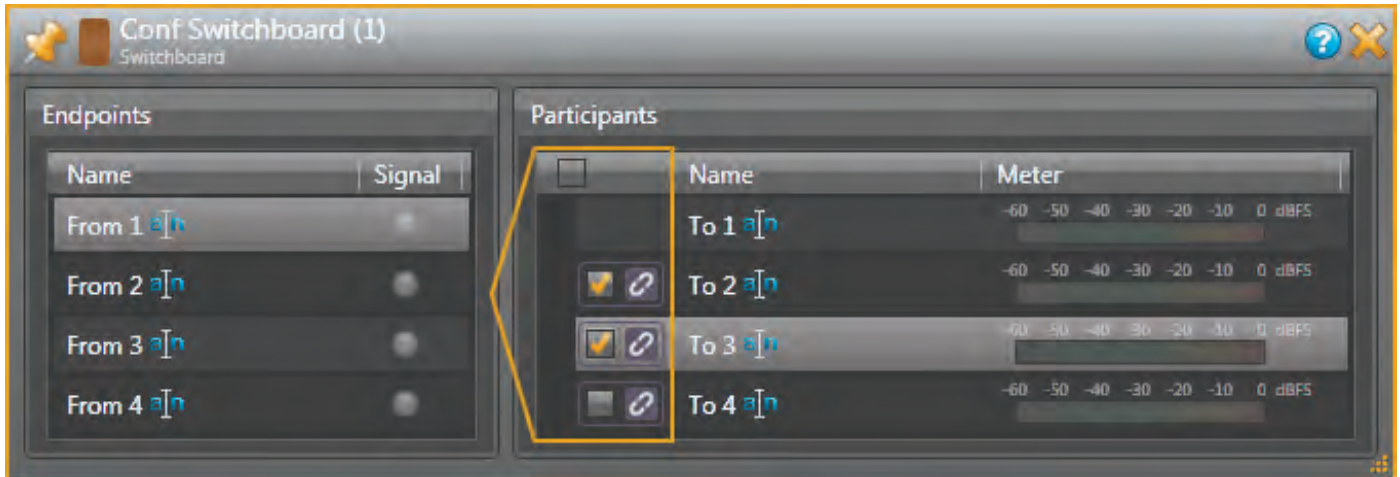

Conference Switchboard

The Conference Switchboard block supports dynamic routing of Far End Audio sources. This block is useful when more than one room must share a single VoIP or Video Conference resource. It's also useful when a room needs to access one or more remote rooms on a campus in order to include them in a conference. In some cases a combination of these scenarios is required.

The function of the Conference Switchboard could be accomplished using a standard matrix mixer, but that would require a user to avoid disallowed routing (like 1:1 or 2:2 etc.), and ensure that To and From Far End pairs are correctly wired. This Conference Switchboard simplifies the process.

Multi-Channel Processing Blocks

In order to get the best performance from an AEC application, the same signal processing parameters used to feed a room loudspeaker must be applied to the AEC reference signal as well. To simplify this process, special blocks that mirror the processing for room and reference channels include:

- Tracking Compressor
- Tracking ANC
- Multi-Channel PEQ
- Multi-Channel Shelf

Conference Room Combine Block

Conferencing in a room combine environment is a complex task without a specialized Room Combine Processor designed to handle room mix, far-end mix and AEC reference routing. Halogen's unique ability to do conferencing within a room combine scenario without complex wiring and routing makes it easy.

Halogen provides a highly integrated Conference Room Combine block that greatly simplifies conferencing in a room combine configuration. The block combines room sources, selects a proper reference, and sends audio to appropriate locations as rooms combine. It also provides support for maintaining a proper AEC Reference with local Voice Lift.

This block supports unique mixes from Record and Room outputs. An independent AEC Reference Output is provided for each room to accommodate various microphone locations and unique room processing outside the Conference Room Combine block.

Also inherently provided in this block are support for background music selection and paging per room.

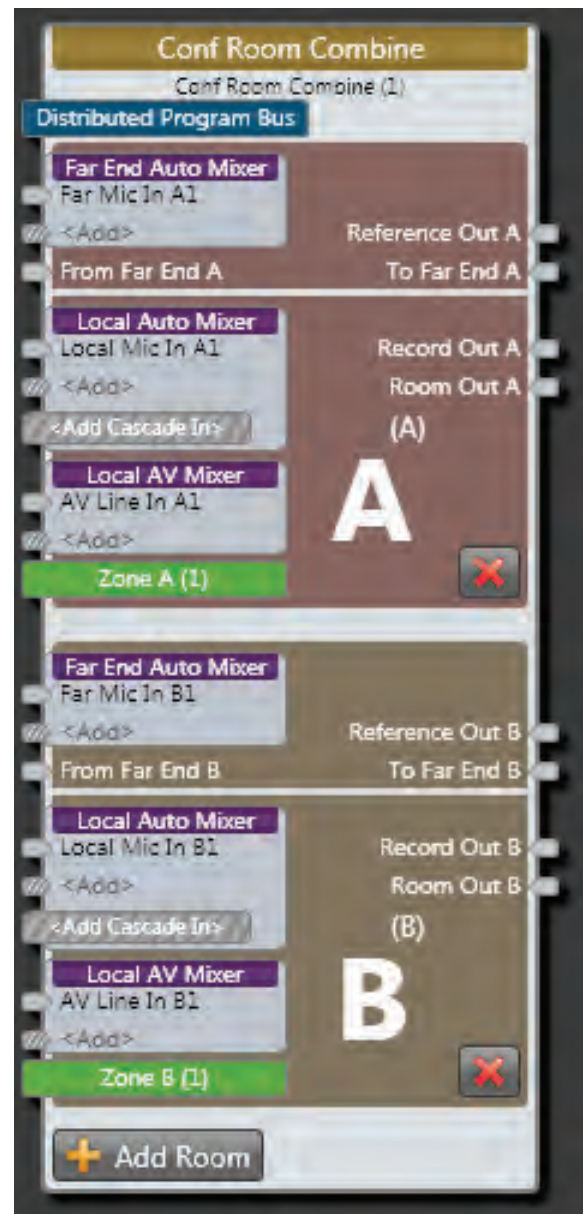

Example HAL1x Boardroom System with AEC

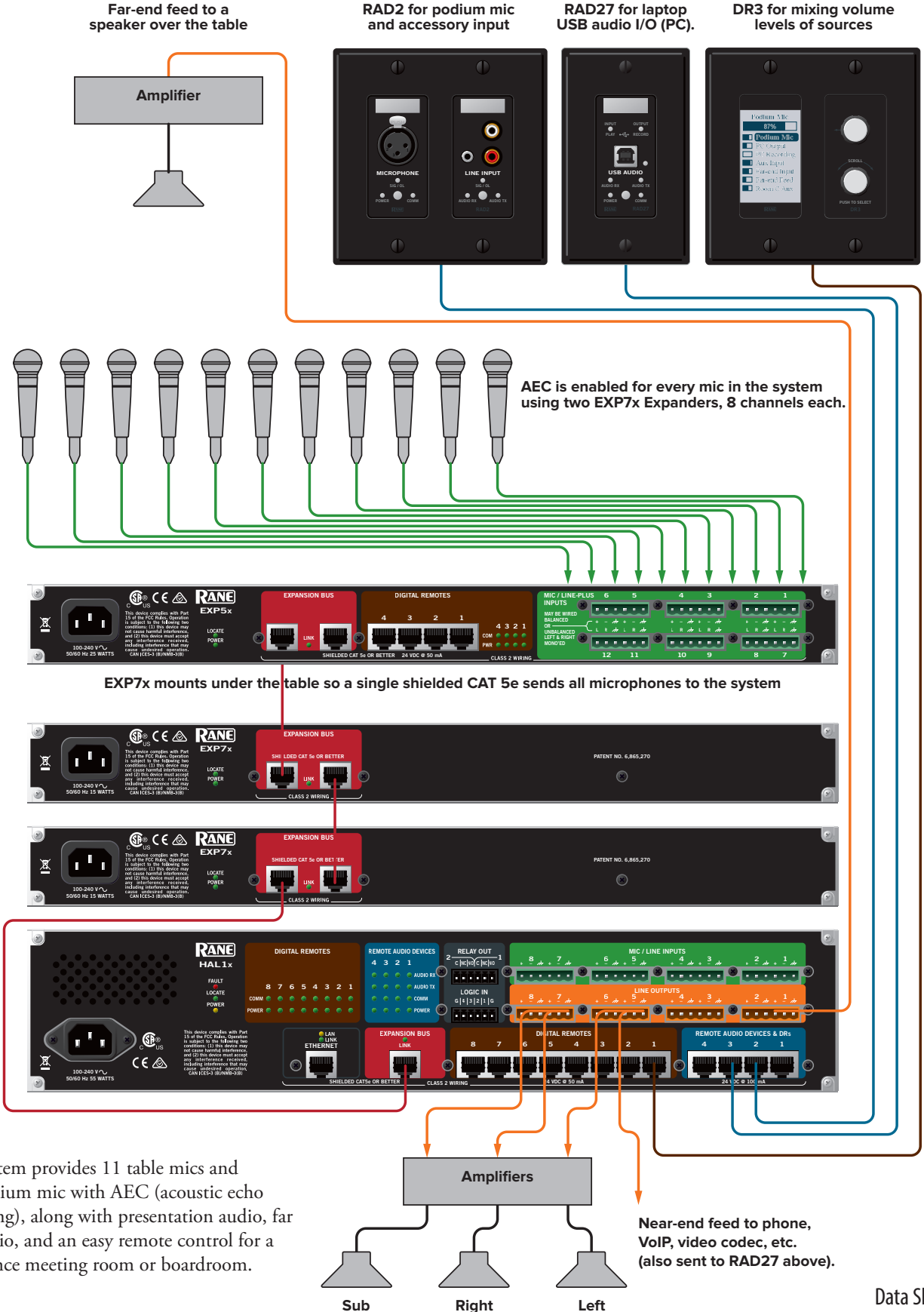

This system provides 11 table mics and one podium mic with AEC (acoustic echo cancelling), along with presentation audio, far end audio, and an easy remote control for a conference meeting room or boardroom.

Example HAL2 House of Worship or Auditorium with Web Controls

Halogen Web Controls allow easy audio system control from any laptop or tablet. An auditorium, lobby and an overflow room receives audio from an aux source and one of two mics in the main auditorium. Adjust levels, change EQ, and mix each room from anywhere. The "Mix Panel" and "Input Control" buttons at the bottom right switch between the two screens.

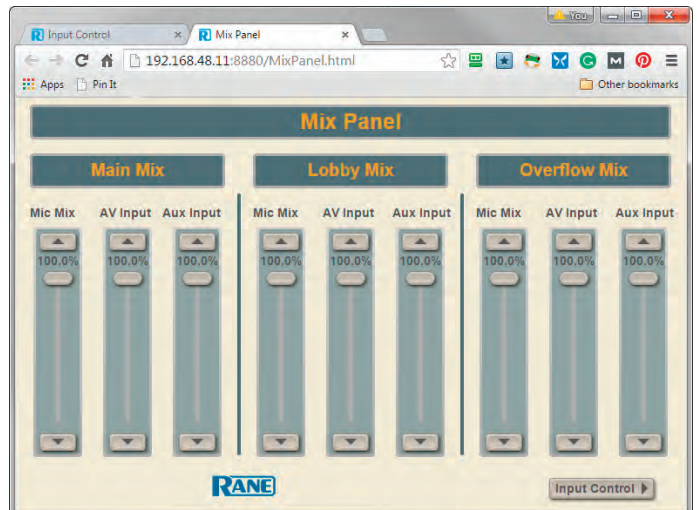
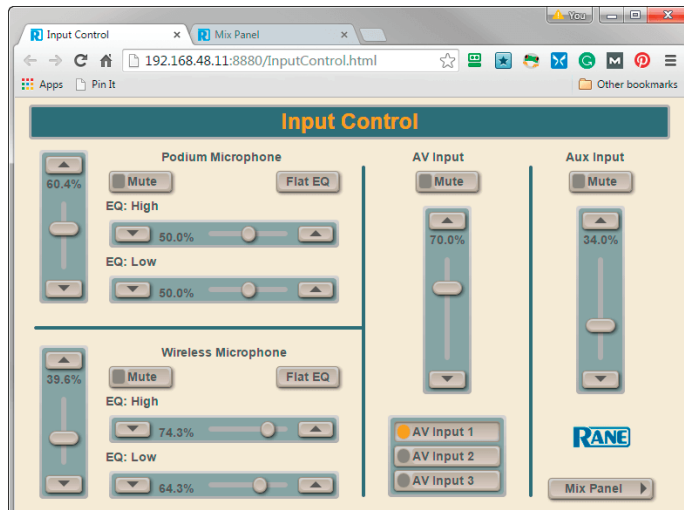
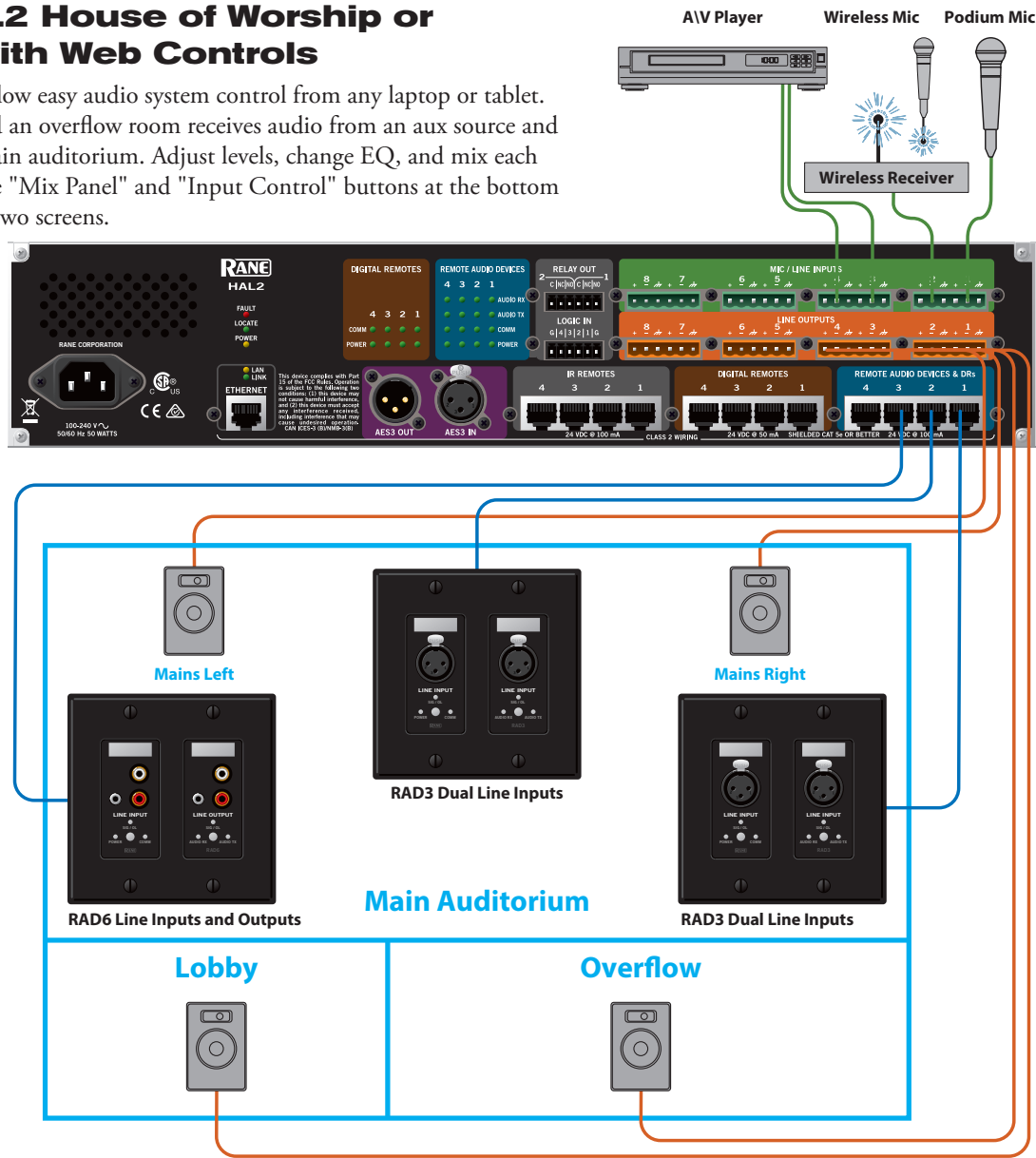

Example HAL3s Restaurant Music and Paging System

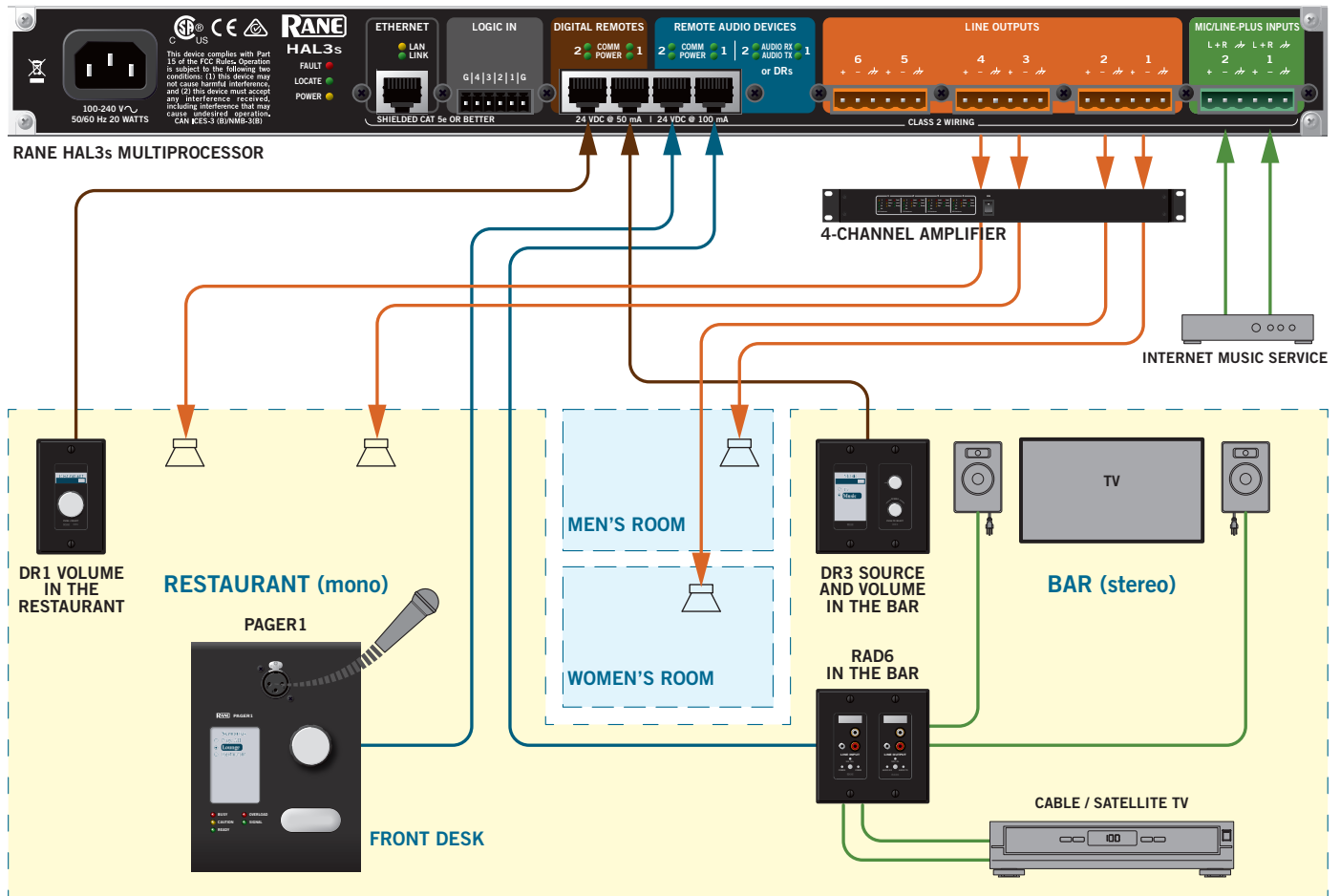

- A RAD6 located in the bar connects the cable box, and an easy place to plug in a phone to play MP3s, and provides two outputs for powered speakers on each side of the TV.
- The PAGER1 is located near the entrance with scenarios to:
 - Page the bar when a table is ready in the restaurant,
 - Page the restaurant when someone is needed at the bar.
 - Page the entire restaurant.
- DR3 Source and Level Remote is located in the bar, with easy source selection and volume.
- The manager has access to source and volume controls from the web browser in a laptop, tablet or smartphone. The additional restroom zone volumes can be adjusted here without the expense of another wall remote control.

Your First Restaurant with Halogen

Rane has an easy-to-follow tutorial on creating this system, viewable online and printable in PDF. In this tutorial, you'll learn how to Map the Processing Workspace, Link Remotes to Blocks, Create Web Controls, and Configure the System Settings. Learn Halogen in a fraction of the time it takes to learn other drag-and-drop audio systems.

Find "Your First Restaurant with Halogen" at rane.com/hal > applications



Example HAL4 Music and Paging System

- 2-zone background music and paging
- 1-source stereo or 2-source mono system

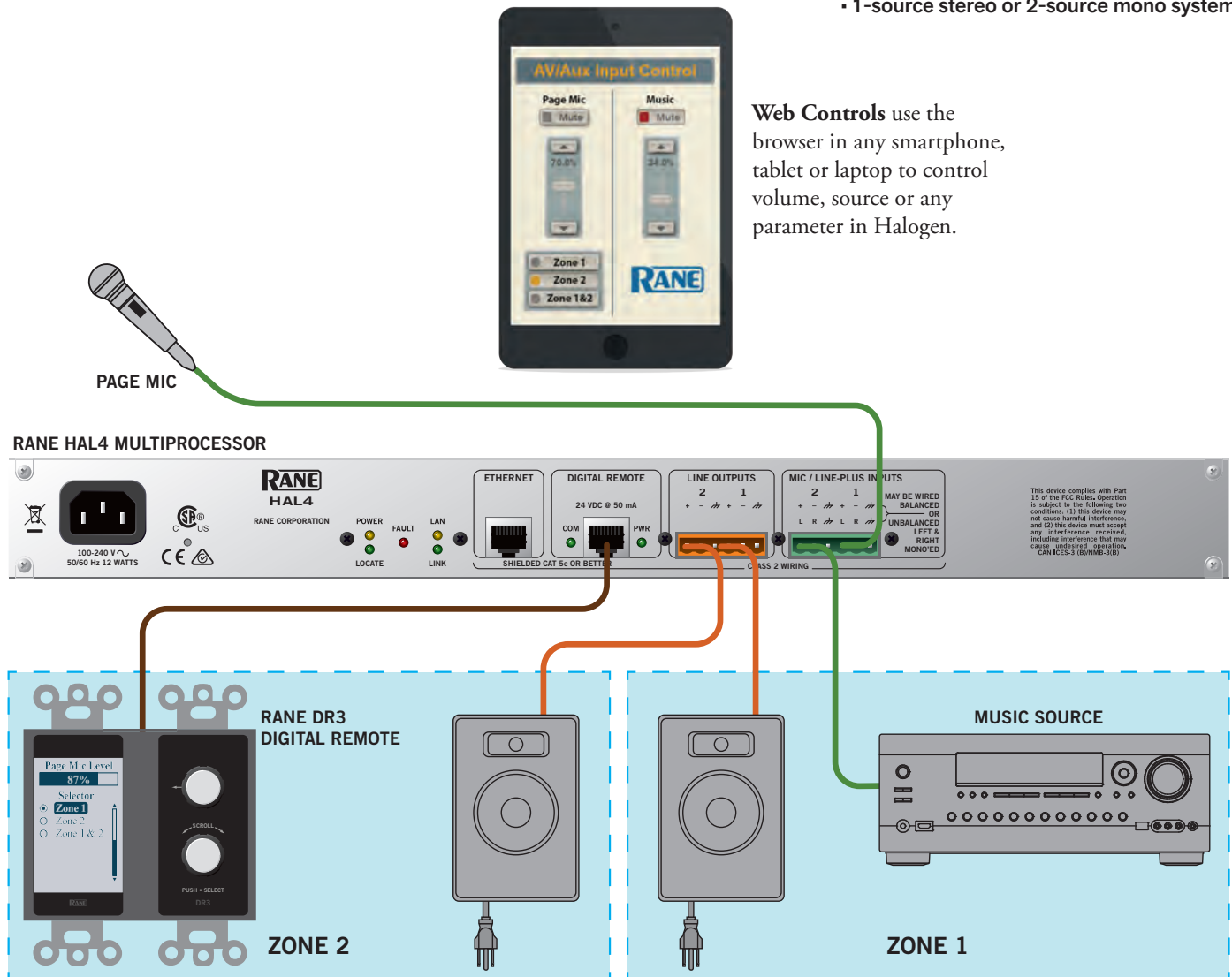

Web Controls use the browser in any smartphone, tablet or laptop to control volume, source or any parameter in Halogen.

Application Notes

Background Music Input: Line-plus mode sums together a left/right stereo pair of inputs into one mono channel.

A **Compressor** block is added with a -30 dB threshold and a ratio of 2:1 for background music comfort, fully adjustable.

Page Mic Input: In Condenser Mode, +48 V phantom power is enabled. The "Active/Inactive" toggle from the Voice Detect Block is linked to the Paging Station block "Talk" input. When the input on the Voice Detect block crosses the input threshold, the page will start.

Paging: Use the "Paging Manager" to connect Paging Stations to Paging Zones. Page Mic 1 can currently page into Zone 1, Zone 2 or both simultaneously.

Linking: A DR3 remote selector is linked to the Paging Station selector so a user may choose which zones are receiving a page. A DR3 remote level is linked to the Page Level so a user may adjust the volume of the page (in all zones). See the "Linking" panel for a list of all control links.

An **Output Limiter** block is added with a -6 dB threshold for speaker protection, fully adjustable.

This configuration is included with Halogen for you to customize. Select File > New > Choose Starter Configuration > VoiceDetect Paging.